

# NEXUS

NEW TIMES MAGAZINE

Volume 3, Number 6 OCTOBER - NOVEMBER 1996

PO Box 30, Mapleton Qld 4560, Australia

## CONTENTS

|   |    |  |    |
|---|----|--|----|
| LETTERS TO THE EDITOR.....  | 4  | CEREAL THRILLERS: THE CROP CIRCLES OF '96.....   | 57 |
| GLOBAL NEWS.....  | 6  | <i>By Marcus Allen. This year's bountiful crop-circle harvest in the UK has yielded such intricate, awe-inspiring designs as to defy our comprehension.</i>          |    |
| <i>A round-up of the news you probably did not see.</i>   |    | ALIEN AUTOPSY: ROSWELL OR SOCORRO?.....  | 61 |
| THE PROBLEM WITH POISONOUS PLASTICS.....  | 11 | <i>By Michael Hesemann. Evidence suggests that 'the Roswell film' is not a hoax—but the alien it depicts was retrieved from an earlier UFO crash at Socorro.</i>     |    |
| <i>By Barry Densley. PVCs and phthalates have entered our food chain, disrupting our hormones and even causing cancer. Should they be banned?</i>               |    | AN ET PERSPECTIVE ON EARTH—Part 3.....   | 69 |
| REMOTE-VIEWING: THE ESP OF ESPIONAGE.....   | 17 | <i>With Alex Collier. We complete this ET contactee's report with the Andromedans urging us to live responsibly in peace and love, or woe betide us.</i>             |    |
| <i>By Turan Rifat. Despite their denials, military and intelligence espionage operatives have been using and fine-tuning their RV technologies for decades.</i> |    | THE TWILIGHT ZONE.....   | 74 |
| THE "OCTOPUS" CONSPIRATORS—Part 1.....  | 25 | <i>Strange tales from around/within/off the world. This issue, a crop-circle creation captured on video, and in Canada, an alien civilisation found underground.</i> |    |
| <i>By Kenn Thomas. Writer Danny Casolaro found more than he expected when he began to uncover the crimes of the "Octopus" cabal. He lost his life.</i>          |    | REVIEWS—Books.....   | 79 |
| THE DOBKIN TECHNIQUE: A LIFE-SAVER.....   | 32 | <i>"The Mystery of the Min Min Light" by Maureen Kozicka</i>   |    |
| <i>By Jeffrey Dobkin. Utilising an automatic oxygen-conserving reflex, this simple procedure can help save heart-attack victims by averting brain damage.</i>   |    | <i>"Open Skies, Closed Minds" by Nick Pope</i>   |    |
| EGYPT'S SECRETS: A HIDDEN AGENDA?.....  | 35 | <i>"Encounter" by Kelly Cahill</i>   |    |
| <i>By Graham Hancock. Egyptian authorities have displayed monumental tunnel-vision at Giza, in snubbing researchers and trying to hide the truth.</i>           |    | <i>"Safe As Houses" by David Cowan &amp; Rodney Girdlestone</i>  |    |
| THE KEY TO HUMANITY'S ORIGINS—Part 3.....   | 38 | <i>"Fields of Mystery" by Andy Thomas</i>  |    |
| <i>By David Wood and Ian Campbell. To conclude this analysis, could the very secrets of creation be encoded in the landscape of Rennes-le-Château?</i>          |    | <i>"Popular Alienation" edited by Kenn Thomas</i>  |    |
| WHITE POWDER GOLD—Part 2.....   | 45 | <i>"The White Death" by Julian Cribb</i>   |    |
| <i>With David Hudson. ORMES are superconducting materials with interdimensional properties that can raise our consciousness and restore perfect health.</i>     |    | <i>"Spies" by Ernest Volkman</i>   |    |
| NEW SCIENCE NEWS.....   | 51 | <i>"Mars/Earth Enigma" by DeAnna Emerson</i>   |    |
| <i>A selection of interesting news and views from the underground science network. This issue, we present Carl Cella's do-it-yourself water-fuelled car.</i>    |    | <i>"I Am With You Always" by G. Scott Sparrow, Ed.D.</i>   |    |
|   |    | <i>"The Paradigm Conspiracy" by Denise Breton &amp; Christopher Largent</i>  |    |
|   |    | <i>"The Natural Way to Better Babies" by F. Naish &amp; J. Roberts</i>   |    |
|   |    | <i>"Living with HIV/AIDS" by Peter de Ruyter</i>   |    |
|   |    | <i>"Keeper of Genesis" by Robert Bauval &amp; Graham Hancock</i>   |    |
|   |    | <i>"From Atlantis to the Sphinx" by Colin Wilson</i>   |    |
|   |    | <i>"Secret Power" by Nicky Hager</i>   |    |
|   |    | REVIEWS—Software.....  | 86 |
|   |    | <i>"CyberSayer" by Majistyks</i>   |    |
|   |    | REVIEWS—Audio.....   | 87 |
|   |    | <i>"Blood of the Land" by Burning Sky</i>  |    |
|   |    | <i>"Celtic Destiny" by Bruce Mitchell</i>  |    |
|   |    | <i>"The Trance of Seven Colors" by Maleem Maahmoud Ghania</i>  |    |
|   |    | <i>"If Then...Else" by Candice Pacheco</i>   |    |
|   |    | <i>"A River of Sound: A Collection"</i>  |    |
|   |    | NEXUS BOOKS, SUBS, ADS & VIDEOS.....   | 99 |

# NEXUS MAGAZINE

Volume 3, Number 6  
OCTOBER - NOVEMBER 1996

PUBLISHED BY  
NEXUS Magazine Pty Ltd, ACN #003 611 434

## EDITOR

Duncan M. Roads

## CO-EDITOR

Catherine Simons

## ASSISTANT EDITOR

Ruth Parnell

## EDITORS' ASSISTANT

Richard Giles

## OFFICE ADMINISTRATOR

Janine Carmichael

## CONTRIBUTORS THIS ISSUE

Barry Densley, Turan Rifat, Kenn Thomas,  
Jeffrey Dobkin, Graham Hancock, David Wood,  
Ian Campbell, David Hudson, Carl Cella,  
Marcus Allen, Michael Hesemann, Alex Collier

## LAYOUT & DESIGN

Duncan M. Roads

## CARTOONS

Phil Somerville

## COVER GRAPHIC

Michel Tcherevkoff/The Image Bank

## PRINTING

Warwick Daily News, Queensland, Australia

## AUSTRALIAN DISTRIBUTION

Newsagents Direct Distribution

## HEAD OFFICE - All Correspondence

PO Box 30, Mapleton, Qld 4560, Australia,

Ph: +61 (0)74 42 9280; Fax: +61 (0)74 42 9381

e-mail address: nexus@peg.apc.org

web page: <http://www.peg.apc.org/~nexus/>

## NEW ZEALAND OFFICE - PO Box 34735,

Birkenhead, Auckland. Ph: +64 (0)9 416 7320;

Fax: +64 (0)9 416 7340

## USA OFFICE - PO Box 177, Kempton, IL 60946-

0177. Ph: (815) 253 6464; Fax: (815) 253 6454

web page: <http://www.icom/nexus/>

## UK OFFICE - 55 Queens Rd, East Grinstead, West

Sussex, RH19 1BG. Ph: +44 (0)1342 322854;

Fax: +44 (0)1342 324574

## EUROPE OFFICE - PO Box 372, 8250 AJ Dronten,

The Netherlands. Ph: +31 (0)321 380558;

Fax: +31 (0)321 318892

## ITALY OFFICE - c/- Avalon Edizioni, Piazza

Mazzini 52, 35137 Padova. Ph: +39 49 655443;

Fax: +39 49 655443

## STATEMENT OF PURPOSE

NEXUS recognises that humanity is undergoing a

massive transformation. With this in mind,

NEXUS seeks to provide 'hard-to-get' information

so as to assist people through these changes.

NEXUS is not linked to any religious, philosophical

or political ideology or organisation.

## PERMISSION-TO-REPRODUCE POLICY

While reproduction and dissemination of the

information in NEXUS is actively encouraged,

anyone caught making a buck out of it, without

our express permission, will be in trouble when

we catch them!

## Editorial

Welcome to the pages of another bumper issue of NEXUS!

I have left writing the editorial until last, in the hope that something inspirational would fill my brain and flow out onto this page. But, alas, I fear that all you are going to get in this editorial are my enthusiastic ravings about the articles in the following pages.

Our first article covers the dangers of plastics. This is a subject you will be hearing a lot more about in the mainstream media, as much more information is coming to light and many groups are lobbying for a safer replacement.

Out-of-body fans and espionage freaks will all enjoy the article on Remote Viewing. If anybody goes OOB (out of body) into Pine Gap, or suchlike, be sure to let me know what you see! Be warned, though: some people claim there are 'astral' safeguards around such places. I won't be responsible for any zombie ex-readers wanting a refund, though!

Also this issue is an article by a great guy called Kenn Thomas. Kenn is the Editor of US-based Steamshovel Press, one of our favourite conspiracy zines. His article on Danny Casolaro, JFK, UFOs, etc., etc., and the links between them all, will satisfy our conspiracy readers out there.

Our other health-based article is about the Dobkin Technique. Everyone should read it (it is only two pages long!) as it could save someone's life. It is so simple and so brilliant. I have had it in my "possible articles this issue" tray for nearly two years, so I am happy to be able to publish it at last.

Renegade archaeological researchers will hopefully appreciate the update on the politics surrounding the mysterious chambers and tunnels under the Sphinx and the Great Pyramid. Are these the legendary Halls of Records? The author, Graham Hancock, suggested to me that readers might like to lobby the Egyptian Consulate in their country, to make public any findings instead of keeping them secret.

I have taken a punt and published a very interesting set of instructions on how to make your car run on water. Previous attempts have failed, so if you are reading this, we made it to print and you should take these instructions (in Science News) to your nearest (friendly) mechanic or mad scientist and see if he can make them work for you.

Marcus Allen, who runs our UK office, has kindly submitted a brief piece on the latest crop circles. The formations this year are quite spectacular!

Michael Hesemann, Editor extraordinaire of Magazin 2000 in Germany, has written a very in-depth article challenging the popular belief that the Santilli autopsy film is a hoax. Armchair UFO 'researchers' might want to take note of some of his findings!

This issue sees the last of the lecture with Alex Collier on the Andromedan perspective of Earth, although there is a fair bit of his own perspective thrown in, too. I am sure I will get the usual flood of letters praising the article, plus those few who write me each issue asking why I publish this sort of material. Oh well, you can please some of the readers some of the time...

I leave you with a little humour sent to me via the Internet. 'Til again...— Duncan

## "PSYCHIATRIC HOTLINE RECORDING:

"Hello! Welcome to the Psychiatric Hotline...

If you are Obsessive Compulsive, please press 1 repeatedly.

If you are Co-Dependent, please ask someone to press 2.

If you have Multiple Personality Disorder, please press 3, 4, 5 and 6.

If you are Paranoid-Delusional, we know who you are and what you want; just stay on the line till we can trace your call.

If you are Schizophrenic, listen carefully and a little voice will tell you which number to press."

## WARRANTY AND INDEMNITY

Advertisers upon and by lodging material with the Publisher for publication or authorising or approving of the publication of any material INDEMNIFY the Publisher and its servants and agents against all liability claims or proceedings whatsoever arising from the publication and without limiting the generality of the foregoing to indemnify each of them in relation to defamation, slander of title, breach of copyright, infringement of trademarks or names of publication titles, unfair competition or trade practices, royalties or violation of rights or privacy AND WARRANT that the material complies with all relevant laws and regulations and that its publication will not give rise to any rights against or liabilities in the Publisher, its servants or agents and in particular that nothing therein is capable of being misleading or deceptive or otherwise in breach of the Part V of the Trade Practices Act 1974. All expressions of opinion are published on the basis that they are not to be regarded as expressing the opinion of the Publisher or its servants or agents. Editorial advice is not specific and readers are advised to seek professional help for individual problems.

© NEXUS New Times 1996



# Letters to the Editor ...

## UFO Concern

Dear Mr Roads: It has been suggested that I should take the initiative to establish an informal group of sensible and respected people who are genuinely concerned with the implications of the UFO phenomenon now manifest worldwide, including Britain.

The aims of such a group would include the dissemination of information based on facts, not fiction, together with recommendations for appropriate action.

I have been personally interested in this baffling but challenging problem for many years, and I am in touch with several others who share my view that strenuous efforts should now be made to address the problem.

I recently circulated a memorandum to people I know who share my concern about UFOs, with good results, and I am encouraged to believe that it would now be useful to bring it to the notice of others who might reasonably be interested, such as readers of your magazine. This would help us to assess the extent of public concern which actually exists about the contemporary UFO situation.

If you feel able to give some publicity to this, I shall naturally be very glad to hear from any of your readers who might care to get in touch. (SAEs would be welcome.)

Yours sincerely,

Admiral of the Fleet The Lord Hill-Norton, GCB, c/o The Old Store, Athelney, Burrowbridge, Bridgwater, Somerset TA7 0SE, United Kingdom.

## Human Guinea-Pigs

Dear NEXUS Magazine: I am writing to express my thanks for the item in Global News (vol. 3, no. 2, page 8), headed, "Outrage Continues over US Radiation Experiments on Citizens".

These abominations were carried out on patients without their knowledge or consent. BBC 1 showed a programme called *Dangerous Experiments* in which babies were injected with plutonium while still in the womb. Mothers were fed with radioactive iron; most died of induced cancer.

What is little known is that people in this country were involved also. This was called the "Churchill Project", in conjunction

with the US military, to test the effects of radiation on humans. I was one of the guinea pigs!

Suffering from an overactive thyroid condition, I was told I would need to be transported to a Bristol cobalt unit for a 'new' treatment.

After a week of isolation and doses of radioactive iodine, I was informed that it was insufficient. Out of thirty patients, I had to remain another week to receive further treatment. This resulted in my being given an overdose. In consequence, my thyroid was damped down too much and I have had to take thyroxine tablets ever since. Now I am very slow, overweight and suffering.

I was surprised when I read the article in NEXUS. I do know there are some others here who have also suffered, but I am having a job finding them. I am hoping if they read this letter they will contact me, as I intend joining the American group of protesters.

Once again, thank you for keeping this subject in the public eye.

Joan Amos, Lucy Cottage, Peter Tavy, nr Tavistock, Devon PL19 9NN, UK.

## Spreading the Word

Dear Duncan: Your magazine and topics within have inspired me on a crusade for many years now, to spread suppressed information and make people more aware around me. I ask all the readers out there to strike a blow against Big Brother by spreading as much information as they can about NEXUS-related topics that have been kept from the general public for many years. Big Brother has long ago secured control of the public by keeping us ignorant and undisciplined as well as disorganised, confused and distracted with matters of very little importance.

They have sabotaged our mental abilities by providing us with very low levels of education and on so many occasions have discouraged technical creativity unless it has suited their needs. They have appealed to our emotions and have promoted self-indulgence in physical and emotional activities with a constant barrage of sex, violence and war on TV and other forms of media. We have been deprived of what we really need, and that is the truth.

Big Brother has also rewritten

history and law and has altered our thinking from personal needs to highly fabricated needs to fabricated priorities. Historical fact has been replaced by historical fiction. Greed has become a primary motive for deception and it is saddening to think that so few at the top have twisted and corrupted the system that we know as society at the expense of so many at the bottom.

Let's not so blindly indulge ourselves in Big Brother's experiments. They have confused us enough over the years, if not centuries, and have found that there is much profit in confusion. Don't be one of the confused or ignorant. Question everything. Help your fellow being and spread the news of this deceit and deception. Thank you.

Yours sincerely, Darren T., Epping, NSW, Australia.

## Hormone Hindrance & Help

Dear Duncan: I have just discovered NEXUS, and I am delighted with it. I enjoyed both the articles and the jokes, and am responding to the "Hormone Heresy" articles.

I use Pro-gest, a natural progesterone, which unfortunately is available in the UK only by prescription. None of the doctors I approached in England and Scotland would give me a prescription for this product, saying it had not been tested. All of them, including a female doctor at the Menopause Clinic in Oxford, wanted to put me on HRT, which makes me feel ill in the same way that the Pill made me feel ill.

Then, I discovered that I could have it sent abroad without a prescription. I now get the distributor in England to send the jar of Pro-gest cream to Spain, where a friend of mine mails it back to me in Scotland.

I find it has all the benefits of HRT, with none of the side-effects, and I am planning to set up a distribution centre in Spain.

So, if any woman in the UK cannot get a prescription for natural progesterone cream, please write to me.

I also drink my urine every morning in order to recycle my hormones, which isn't half as bad as it sounds. If I stay on a healthy diet, it tastes like vegetable water!

With thanks and appreciation,

Marilyn Barry, Raphael Cottage, Findhorn, Forres IV36 0YY, Scotland, UK.

## Pine Gap and OOBES

Dear Duncan: I am writing to enquire whether or not you, or anyone else, know of any information relating to the US super-secret Pine Gap facility located near Alice Springs in central Australia.

As much as I have tried, I have not been able to discover much about this subject at all (apart from brief references within NEXUS and a less-than-helpful web site).

If you publish this letter, please don't leave it without a reply, as it is rather frustrating to read a letter which poses a question, only to discover there is no answer from you.

Also, would it be possible to do any articles on out-of-body experiences (OOBES), as I—and many others, I'm sure—find this realm of human experience intensely interesting.

Apart from that, I commend you on such a revealing magazine, and hope to see you expose the truth for many years to come.

Yours sincerely, Zach L., Hobart, Tasmania, Australia.

[Dear Zach: Everybody would like to know what really goes on inside Pine Gap and many other such bases around the globe, but we just don't. As for out-of-body experiences, I strongly suggest you read Robert Munroe's books, especially *Far Journeys* (available at any good, independent bookstore). You might also refer to the "Remote Viewing" article in this issue. Good luck! Ed.]

## Aspartame Anguish

Dear Sir: I went through the horrors of aspartame in 1986. I was drinking several big gulp-sized glasses of Diet Coke per day. After several months of increasing depression and rage, I went into a seizure that lasted close to four hours.

At this time, I was a trauma/ICU nurse, and the trauma doctor who took care of me in the ER was a friend. I came off the crap, but went through severe, classic-style drug-withdrawal symptoms for a week.

I later found out at the gym, where I was working out, that the power-lifters were 'slamming'

# ... more Letters to the Editor

NB: Please keep letters to approx. 100-150 words in length. Ed.

large quantities of aspartame-loaded drinks (a handful of aspartame packages into 2-litre Diet Cokes) and shooting up with steroids. They found that they 'bulked up' quicker with the aspartame.

Few people believe in the truth. This crap nearly killed me and nobody wants to believe me.

Keep up the good information!

David R., Ph.D., USA.

## Automatic Terror Machines?

Dear Ed: Maybe some of your readers that are aware of high-frequency leakage have heard of something similar to an eerie happening I had with a bank ATM [automatic teller machine] one Saturday morning.

After inserting my card, the screen read: "YOUR CARD HAS BEEN KEPT FOR SECURITY REASONS AND YOU HAVE BEEN PHOTOGRAPHED".

From then on, a strange feeling came over me, and my vision focussed entirely on the ATM as the glass walls and building disappeared. I felt the ATM was bullying me and stunning me, while refusing to give my Flexicard back, as the event deepened personally.

Two to three weeks later, the details of the event became apparent through recall only. I was totally overwhelmed from any awareness of the conscious state of mind when it happened.

I had 'lost time' for the rest of the Saturday and Sunday, and reported to my doctor symptoms of numbness in the fingers and toes, severe memory-loss, a loud background hiss in my ears; overall, I felt like I was 80 years old (I am 44).

It would be nice for me to hear that this is not an isolated case.

Regards, Ron M., Byron Bay, NSW, Australia.

## NZ Eruptions Prophecy

Dear Ed: I would like to call your readers' attention to a prophecy of Miss Frances Yule, made in 1980 and published in 1982, to the effect that volcanoes would erupt in many parts of the world in 1996, including New Zealand.

You will have heard of the eruptions of Mount Ruapehu in New Zealand's North Island in late 1995 and in June 1996, which may

be the precursors of greater events such as described by Mother Shipton:

"Three sleeping mountains gather breath; And spew out mud, and stones [ice] and death./...In lands as yet to me unknown." [See NEXUS, vol. 2, no. 24.]

These would be Ngauruhoe, Ruapehu and Tongariro, situated in the thermal area south of Lake Taupo. Should your readers doubt that such a thing can happen, then they should visit the crater of Mount Tarawera, and the buried village where many died in the 19th century, and consider that the city of Auckland is built entirely on volcanic cones! Some of these, like Mount Smart, have a habit of erupting once every few hundred years and, judging from the observable landscape, the next is due any day.

Prophecy is *useless* unless it is dated. I think it would be more useful to your readers in Australia and New Zealand if you would publish the prophecies of Miss Yule, rather than the obscure, outdated and unconfirmed predictions of a Yugoslavian seer. [See NEXUS, vol. 3, no. 3.]

Yugoslavia was, in fact, one of the thirteen countries and regions listed by Miss Yule in 1980 as slated for destruction. And so it was.

Anthony B. Pollock, 15 Homewood, Findon, West Sussex BN14 0XA, UK.

[Dear Anthony: I'm keen to read the prophecies. Send them to me any time you want! Ed.]

## Create Your Own Reality!

Dear Duncan: I'd like to comment on your last editorial, where you discussed the alternative reality that NEXUS offers, and how it blows the minds of new readers until they form a new framework with which to view our reality.

My comment is, how easy it is to focus so wholly on the suppression/tyranny reality that it does in fact become reality. The point I want to make is that even though there are a large number of people in leadership roles that we know of, and behind the scenes, who operate at this vibration, it only needs to be your reality if you make it so. We create our own reality by what we focus on.

I have an analogy. It is as though you are sitting in a room

and in one corner there is something gross and uninviting, and in the other there is something beautiful, like a vase of flowers or a child playing. You can sit there and look at the gross thing or, alternatively, the beautiful thing.

I know that NEXUS is a process and for a long while the lowest intentions harboured on this planet can become all you can see. It is important, essential, to know what they are. But they don't have to become our reality, because the 'real' reality is the love of our family and friends, and all the high qualities in mankind.

I absolutely love your magazine. Thanks!

Love, Linda A., Carrum, Victoria, Australia.

[Dear Linda: No matter how much you sit there looking at the beautiful thing, the gross thing will still be there. Not only that, but by excluding the gross thing you are not getting the whole picture of what is in the room. I get the impression that people read magazines like NEXUS because they want to know what else is in the room. Ignoring problems does not make them disappear. But, I agree with you that if you address the highest in yourself and others, you will see differently what is gross, and for the better. Ed.]

## Medicinal Marijuana

Dear NEXUS: Regarding the article on medical uses of marijuana in vol. 3, no. 5 [Aug-Sept '96], did it ever occur to anyone to use the plant as *other* herbs are used, namely, tinctures, teas or capsules?

The human lung is not designed to tolerate *any* burning substance, and smoke of *any* kind contains many carcinogenic compounds. Hundreds of herbs are found in health food stores and *none* is smoked (that I know of). Maybe the old 'hippie brownies' are the way to go?

Research should be done into 'standardised extracts' of marijuana, if it is to be used medicinally.

Charles Thaxton, Apple-A-Day Health Foods, Findlay, OH, USA.

## Too Much Negativity?

Dear Editor: We found NEXUS very intriguing and interesting over the past two years, especially as psychically we have channelled

much of the information that you have printed before we ever saw the magazine.

We did wonder, though, if you were aware that so many of your articles, besides being rather out of date, can be very negative and depressing for so many people, could even spread a great panic worldwide.

This is the battle we have taken upon ourselves: to prevent the spread of fear and, by doing so, giving people back their own power to be strong enough to fight off the mind wars that are going on from, and between, governments and those so-called Illuminati.

We do this by opening the doorway to empowerment, through teaching them to dowse, to channel and to heal. This is the way to learn how to be in total control of your life, your health, your work, regardless of who or what one is. It does not matter what circumstances upon the ladder of class, creed, colour or culture one is. Anyone can learn to empower themselves within their own minds, where no matter how hard "they" may try, "they" cannot have any influence unless we allow "them" to have it!

Please, please may we have some articles of encouragement also in NEXUS, if only to keep a better balance? Looking forward to the next issue!

Yours sincerely, Jeanne Collins, Unique Solutions (Paranormal), Hacche Barton, South Molton, Devon, EX36 3EH, UK.

## Port Chicago Cover-up?

Dear Duncan: Concerning "America's Dark Secret", June-July '96 (vol. 3, no. 4), apparently two railroad cars of munitions were buried after exposure in the Port Chicago Disaster. Perhaps they were radioactive? I received the following enclosure [extracted below] and am passing it on to you:

"Naval Weapons Station, Concord, California—Environmental Cleanup Process: Inland Area Sites

"Site 8, Ryer Island: Two railroad boxcars loaded with munitions were reportedly buried on the Island after a 1944 dock explosion."

Best wishes, Paul Schaefer, *News of the Weird*, USA.

# GLOBAL NEWS

## HERBAL CANCER CURE

NEXUS was one of the first magazines to give international exposure to the research of Dr Hulda Clark (see NEXUS, vol. 2, nos. 22, 23). We thought readers might like to read one of many success stories that have resulted from using Dr Clark's treatments.

"I used to practise medicine using unorthodox approaches in Scottsdale, Arizona, until I was set up by the authorities and lost my licence to practise there. I came to Ecuador, where there is freedom to treat as you see fit.

"One amazing case I have is a five-year-old boy with Ewing's sarcoma, with tumours in his armpit and chest wall. He made the rounds from Miami Children's Hospital to Johns Hopkins Medical Center, where he was operated on and given the maximum doses of chemotherapy and radiation. Finally, he was sent back to Ecuador to die.

"He arrived in my office with a catheter in one of the veins of his heart, where his mother could give him injections of morphine for his intense pain.

"I started him on increasing doses of anti-parasite herbs, according to the recommendations of Dr Hulda Clark (*The Cure For All Cancers; The Cure For All Diseases*). It is hard to believe, but this child was off morphine and the oral painkillers within 24 hours. His appetite

returned, and I took him off the junk food he had been allowed to eat.

"Within two weeks, he returned to the activities of a normal five-year-old. His tumours are regressing and his blood levels have returned to normal. His only medications consist of vitamins, herbs and enzymes.

"Had I been confronted with this case in the USA, the program I put him on would have resulted in board action, media criticism and possibly a malpractice suit.

"Saving one life was worth the misery I went through. (Signed) R. B., Ecuador."

(Source: *What Doctors Don't Tell You, UK*, vol. 7, no. 4, July 1996)

## THOUGHT-POWER

Pilots are testing a revolutionary new system that will enable them to fly planes using thought-power.

Dr Andrew Junker, a UK-based electrical engineer and neuro-physiologist, has spent 25 years working towards creating machines that can be controlled by the mind.

The Cyberlinks Interface allows the user to send thought commands through a headband, and works by interpreting an assortment of undulating electrical pulses emitted by the brain.

Dr Junker's company, Cyberlink Mind Systems, is planning to apply the device to commercial uses, such as wheelchair-steering for the disabled, and in aviation, with commercial and military pilots using the system to fly planes.

A basic Cyberlink system for disabled people to operate a typewriter/computer keyboard will be on sale by Christmas 1996 and is expected to cost about AUD\$1,500. A thought-powered wheelchair, the Cyberchair, will be available within a year, with a retail price of around AUD\$20,000.

Test pilots using a flight simulator dome at the Wright Patterson Air Force base in Ohio, USA, have already demonstrated that commercial and military jets can be flown hands-free using the Cyberlink system.

(Source: *The Sunday Telegraph, UK*, 11 August 1996)

## "SOUL CATCHER" IMPLANTS

British scientists are developing a concept for a computer chip which, when implanted into the skull behind the eye, will be able to record a person's every lifetime thought and sensation.

"This is the end of death," said Dr Chris Winter of British Telecom's artificial-life team. He predicts that within 30 years it will be possible to relive other people's lives by playing back their experiences on a computer. "By combining this information with a record of the person's genes, we could recreate a person physically, emotionally and spiritually."

Dr Winter and his team of scientists at BT's Martlesham Heath Laboratories, near Ipswich, call the chip "the Soul Catcher".

British Telecom would not divulge how much money it is investing in the project, but Dr Winter said it was taking "Soul

## ACCOMMODATION

Self-contained studio. Big skylight. 360° views. Cool in summer.



Basement flat. Located in green belt. Hole in roof.



Penthouse. Fully detached. Deep pile carpets. Air conditional.



Catcher 2025" very seriously. He admitted there were profound ethical considerations, but emphasised that BT was embarking on this line of research so it could keep at the forefront of communications technology.

Dr Winter said, "An implanted chip would be like an aircraft's black box, and would enhance communications beyond current concepts. "For example, police would be able to use it to relive an attack, rape or murder from the victim's viewpoint, to help catch the criminal... I could even play back the smells, sounds and sights of my holiday to friends."

Other more frightening applications include downloading an older person's experiences into a newborn baby by transplanting the chip.

The device is expected to be on sale by 2025, so look out!

(Sources: *The Daily Telegraph, UK; Daily Mail, UK, 18 July 1996*)

**HUMAN TISSUE TO MAKE ANIMAL-TESTING REDUNDANT**

The first pharmaceuticals company to test drugs exclusively on human tissue is to start business in October this year. Pharmagene, based in Hertfordshire, England, will only use human tissue and will not conduct any research on animals.

Animal rights groups see the move as a step in the right direction. "We've said for some time that the best science, as well as the most humane science, is based on examination of human rather than animal tissue," says Andrew Tyler, Director of the lobby group, Animal Aid. The group launched a donor card scheme in 1991 so that people could offer their tissue for research if/when they died. So far, over 250,000 people have joined the scheme.

(Source: *New Scientist, UK, 31 August 1996*)

**ROTHSCHILD DEATH MYSTERY**

Rumours abound as to the method of and motives for the death of Amschel Rothschild, heir to the fabulous Rothschild banking fortune.

Depending on which newspaper you read, his death has been reported as a suicide from hanging, a heart attack, a suicide from strangling, and a murder.

One news report stated that a massive media cover-up was ordered by magnate Rupert Murdoch, who allegedly faxed "his 600-odd editors and news managers around the world, ordering them to report Amschel's death as a heart attack, if at all".

British broadcast reporter, Ian Gooding, is quoted in the *Spotlight* as saying: "No one around here has ever seen such pressure to kill a front-page story. But in the end, the cover-up was complete."

Whatever the cause or reason, Amschel Rothschild's death is surrounded by mystery. His body was discovered on the bathroom floor of his suite at the luxurious *Hôtel Bristol* in Paris, at 7.32 pm on 8th July. French police found that he had been strangled with the end of the cord of his own bathrobe. One end of the cord was found attached to a towel rack, as if to suggest that his death was self-inflicted.

Many French reporters claim that the (French) police never called the death "suicide". Apparently, after photographing the body and the crime scene, one of the detectives gave the towel rack a sharp tug and it came right out of the wall.

No suicide note was found, and no discernible cause or reason appears to exist for a finding of suicide.

(Sources: *Weekly Telegraph, UK, 17-23 July 1996; The Australian, 12 & 15 July 1996; The Spotlight, USA, 5 August 1996, alt.conspiracy newsgroup on the Internet*)

**NZ SPY-BASE KEEPS POLITICIANS 'OUT OF THE LOOP'**

New Zealand-based peace activist, Nicky Hager, has revealed in his new book, *Secret Power*, that NZ (and Australian) politicians, including the NZ Prime Minister, were kept uninformed on matters of intelligence-gathering and information-sharing.

(See Book Reviews this issue.) Former NZ Prime Minister David Lange states in the book's foreword that he had no idea New Zealand had been committed to an international, integrated, electronic network.

The book and the resulting media publicity sent the local intelligence community (an oxymoron, to be sure) into damage control. Their response, fed to the public through selected journalists, was to claim that the information contained in the book was already a matter of public record and, anyway, it probably wasn't very useful.

Mr Lange says, "...it is an outrage that I and other ministers were told so little, and this raises the question of to whom those concerned saw themselves ultimately answerable."

The surveillance system, revealed publicly for the first time, operates under the code-name *Echelon*, and falls under the secret pact known as the UKUSA Agreement (see NEXUS, vol. 2, no. 27).

It would appear from the disclosures in *Secret Power* that the *Echelon* network routinely intercepts civilian phone, fax and e-mail traffic, and shares this information with UKUSA member countries which include the USA, the UK, Canada, Australia and New Zealand.

Just who it is shared with in Australia and New Zealand is probably a matter of some debate behind the scenes right now.

(Sources: *Secret Power, by Nicky Hager; The Australian, 15 & 19 August 1996; Sydney Morning Herald, 15 August 1996; Guardian Weekly, UK, 25 August 1996*)

*Banks as seen by...*

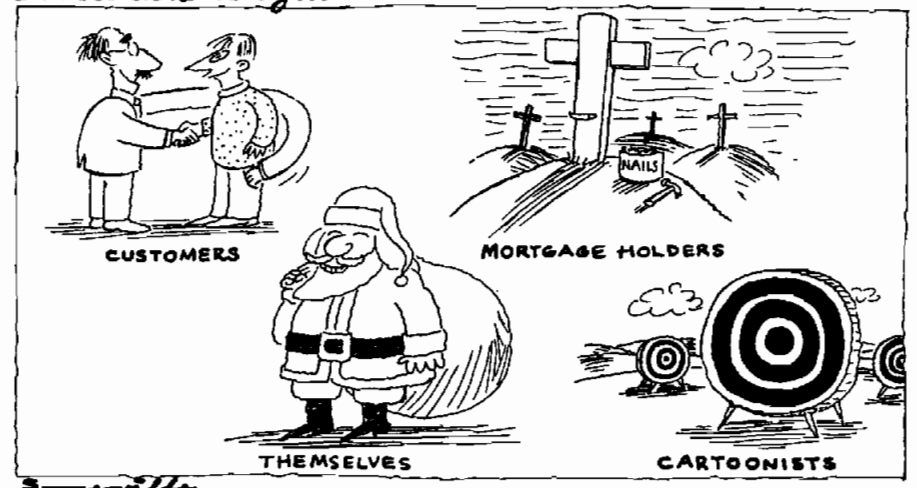

## PHONICS FOR IMPROVING LITERACY SKILLS

A report produced by the Office for Standards in Education (Ofsted) in the UK, dramatically confirmed that the methods used by teachers to teach reading do not work. In fact, 80 per cent of pupils in 45 inner London primary schools could not read properly at the age of seven.

But the significance of the report goes even further than that. For the first time in a generation, it gives unequivocal official endorsement to phonics as the sole, effective foundation to the teaching of reading. It says that, instead of being taught to guess at words or recognise them by their shape, children should learn to sound them out.

According to the report, "Learning the letter-sound system of English comprises a set of knowledge and skills which is basic to learning to read and write an alphabetical script.

"Phonics provides pupils with the knowledge to decode and build words, upon which success in early reading and writing depends, and gives the pupils more confidence they need to tackle new texts."

The situation in the USA is even worse. After years of watching programs like *Sesame Street*, a whole generation of children has regressed in terms of literacy skills. This has led to a dramatic increase in the number of families adopting home-schooling—the only way they can expose their children to a phonics reading system.

Phonics reading systems were abandoned in the UK during the 1970s. Teachers who

persisted in phonics methods found themselves hounded and persecuted by the education bureaucracy.

A phonics technique, the "Spalding method", is being introduced to teachers in Australia. Spalding-trained teachers begin by teaching kindergarten pupils the 45 sounds of the English language, with the help of the 70 "phonogram" cards.

The results are speaking for themselves!

(Sources: *Daily Telegraph*, UK, 15 May 1996; *Sydney Morning Herald*, 29 July 1996)

## BRAIN pH LEVELS AFFECT INTELLIGENCE

A team of scientists led by Caroline Rae at the John Radcliffe Hospital, Oxford, UK, has discovered a link between IQ and pH in the brain's cortex. A higher, or more alkaline brain pH is likely to be associated with a higher IQ, according to tests measuring the acid content in the brains of 42 boys aged between six and 13.

It is the first time that intelligence has been linked to a biochemical 'marker' in the brain, raising the prospect that one day it may be possible to increase intelligence by artificially raising the pH levels in the brain.

The report reveals this was an accidental finding made during a study of children with muscular dystrophy. They were studying the possible correlation between brain biochemistry and intelligent behaviour.

(Source: *The Sunday Telegraph*, UK, 18 August 1996)

## PVC PHASE-OUT?

Will PVC (polyvinyl chloride) be the 'asbestos' of the '90s? Already, battle lines are being drawn between environment and health researchers, and the plastics industry and other organisations it funds.

The "Poisonous Plastics" article in this issue dives into some of the deeper considerations at stake. Meanwhile, we thought readers might like to know that several European countries, including Germany, Sweden, Switzerland and Austria, have instigated moves to phase out PVC at various levels.

(Sources: *The Age*, 2 September 1996; *PVC Fact Sheet*, Greenpeace International)

## WAS IT A MISSILE THAT HIT TWA FLIGHT 800?

Conspiracy theories are thriving amidst the deafening silence from authorities regarding the cause of the crash of TWA Flight 800.

What is adding fuel to this fire is the large number of eyewitnesses who accurately describe an object approaching the 747 just before it burst into flames. Consider the following:

- Many eyewitnesses heard a "sonic boom" which drew their attention skywards and resulted in their witnessing the explosion;
- CNN reported that a radar operator tracking Flight 800 saw on his screen another smaller blip approaching the 747;
- More than 100 eyewitnesses claim they saw an orange flame streaking towards the spot where the plane exploded;
- Two commercial airline pilots reported seeing a missile actually in flight;
- One person at a social event accidentally photographed an object streaking towards the jet. The FBI confiscated all photos except one, which has now been put onto the Internet (see Art Bell's web page).

All these reports suggest to military and intelligence experts that someone fired a "Stinger" missile at the plane. Due to its small weight and size, a Stinger can be carried, positioned and fired by a single person. It has a range of four kilometres and can reach speeds of Mach 2, or twice the speed of sound.

Researchers are worried that authorities will not reveal such a conclusion to the American public for fear of embarrassment, and fear of causing panic over air travel.

(Sources: *Various newspapers, wire services and the Internet*)





## SECRET IMPLANTS ILLEGALLY USED ON PRISONERS

A leaked three-page document has surfaced recently which should make IBM's security division very unhappy. Reprinted below are the first two of those pages:

-----  
INTELLI-CONNECTION  
A Security Division of IBM  
1200 Progress Way  
Armonk, New York 11204

CONFIDENTIAL  
LIMITED DISTRIBUTION ONLY  
LEVEL 9 COMMUNICATION

### 2020 NEURAL CHIP IMPLANT

The control of crime will be a paramount concern in the 21st Century. We must be ready with our security products when the demand for them becomes popular. Our Research and Development Division has been in contact with the Federal Bureau of Prisons, the California Department of Corrections, the Texas Department of Public Safety, and the Massachusetts Department of Correction to run limited trials of the 2020 neural chip implant. We have established representatives of our interests in both management and institutional level positions within these departments.

Federal regulations do not yet permit testing of implants on prisoners, but we have entered into contractual testing of our products. We have also had major successes in privately owned sanitariums with implant technology. We need, however, to expand our testing to research how effective the 2020 neural chip implant performs in those identified as the most aggressive in our society. Limited testing has produced a number of results.

In California, several prisoners were identified as members of the security threat group, EME, or Mexican Mafia. They were brought to the health services unit at Pelican Bay and tranquilized with advanced sedatives developed by our Cambridge, Massachusetts laboratories. The implants procedure takes 60-90 minutes depending upon the experience of the technician. We are working on a device which will reduce that time by as much as 60%. The results of implants on 8 prisoners yielded the following:

- Implants served as surveillance monitoring device for threat group activity
- Implants disabled two subjects during an assault on correctional staff

- Universal side-effects in all 8 test subjects revealed that when the implant was set to 116 MHz all subjects became lethargic and slept an average of 18-22 hours per day

- All subjects refused recreation periods for 14 days during the 116 MHz test evaluation

- 7 of the 8 subjects did not exercise, in the cell or out of the cell, and 5 of the 8 subjects refused showers up to three days at a time

- Each subject was monitored for aggressive activity during the test period and the findings are conclusive that 7 out of the 8 test subjects exhibited no aggression, even when provoked

- Each subject experienced only minor bleeding from the nose and ears 48 hours after the implant due to initial adjustment

- Each subject had no knowledge of the implant for the test period and each implant was retrieved under the guise of medical treatment

It should be noted that the test period was for less than two months. However, during that period, substantial data was gathered by our research and development team which suggests that the implants exceed expected results. One of the major concerns of Security and the R & D team was that the test subject would discover the chemical imbalance during the initial adjustment period and the test would have to be scrubbed. However, due to advanced technological developments in the sedatives administered, the 48-hour adjustment period can be attributed to prescription medication given to the test subjects after the implant procedure.

One of the concerns raised by R & D was the cause of the bleeding and how to eliminate that problem. Unexplained bleeding might cause the subject to inquire further about his "routine" visit to the infirmary or other health care

facility:

The security windfall from the brief test period was enormous. Security officials now know several strategies employed by the EME that facilitate the transmission of illegal drugs and weapons into their correctional facilities. One intelligence officer remarked that while they cannot use the information they have in a court of law, they know who to watch and what outside "connections" they have. The prison at Soledad is now considering transferring three subjects to Vacaville where we have ongoing implant research. Our technicians have promised that they can do three 2020 neural chip implants in less than an hour. Soledad officials hope to collect information from the trio to bring a 14-month investigation into drug trafficking by correctional officers to a close.

Essentially the implants make the unsuspecting prisoner a walking, talking recorder of every event he comes into contact with. There are only five intelligence officers at the Commissioner of Corrections who actually know the full scope of the implant testing.

In Massachusetts, the Department of Correction has already entered into high-level discussions about releasing certain offenders to the community with the 2020 neural chip implants...

*(This communication is dated 20 October 1995, and its distribution is marked: "Eyes Only: Project Group 7A")*

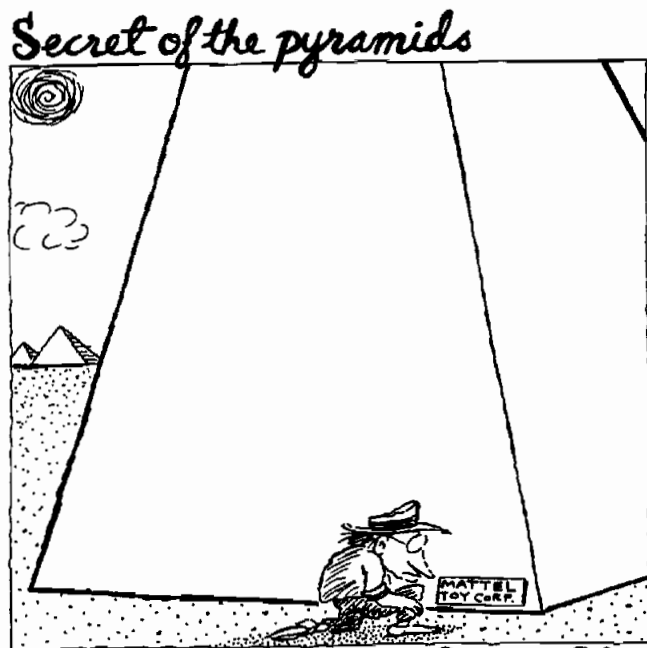



# The Problem with POISONOUS PLASTICS

**New research  
proves that  
PVCs and  
phthalates  
contaminate our  
environment  
and the food we  
eat, causing  
disruption of  
our hormonal  
and glandular  
systems.**

**by Barry Densley © 1996**

c/- HWT, Melbourne, Australia  
Telephone: +61 (0)3 9292 1411  
Fax: +61 (0)3 9292 1177  
E-mail: [bdensley@newscorp.com.au](mailto:bdensley@newscorp.com.au)

*"The agreements between the big oil companies, in particular, show that any law of the state becomes meaningless for them, and that all forms of jurisdiction of the national state are done away with."*

— Dr Fritz Werr, National Socialist economist, 1936,  
quoted in Reimann's *Patents for Hitler* (1942)

**A**s consumers, we implicitly trust food manufacturers and governments to maintain appropriate safeguards to prevent food contamination and its toxic or chronic effects. Australian health officials recently ordered an investigation of locally manufactured baby milk formula, following the discovery of PVC plasticisers or phthalates ("thal-ates") in UK varieties. The Secretary for Health and Family Services, Senator Robert Woods, announced there was no immediate risk to Australians: "This situation in the United Kingdom does not mean we have any reason for concern...we must quickly investigate to see if these substances are present at all in Australian products." Results from Senator Woods' enquiry into phthalates in infant formula in Australia have not been released to date.

A toxic by-product of the petroleum industry, naphthalates (phthalates) were first discovered in the 1850s. From the early 1900s through the 1930s, a number of companies, most notably I. G. Farben (now known as Hoechst, Bayer, Roche and BASF), Standard Oil (EXXON and ESSO) and Shell, developed a wide range of synthetic oil-based products under umbrella patents for commercial use. One of these products, PVC (polyvinyl chloride), is now used in an enormous range of applications in building, electrical, health-care and transport.<sup>1</sup> No known long-term research was ever carried out on the possible systemic effects on either humans or the environment.

A deadly cocktail of chemicals and compounds, such as DEHP, or di(2-ethylhexyl) phthalate, and p-nonylphenol (used to make PVC more stable and impact-resistant), is used in the manufacture of most PVC products. Of these, DEHP accounts for up to 90 per cent of annual global phthalate production (over 3.25 million tonnes). Both DEHP and nonylphenol are potential carcinogens and may disrupt normal hormonal function. There are other possible side-effects which adversely affect reproductive ability, the developing embryo and foetus, and the reproductive ability of offspring, as well as disorders which cause delay or lack of conception, such as menstrual disorders, hormonal problems, impotence, sperm abnormalities, and uterine fibroid and tubal defects. Adverse birth effects may include spontaneous abortion, stillbirth, toxæmia, low birthweight, congenital defects and childhood cancer.

Phthalates and the stabiliser nonylphenol are xeno-oestrogens, in that they mimic naturally-occurring oestrogens, and are thought to disrupt the body's complex chemical communications (endocrine) system. This system consists of a number of glands—pituitary, thyroid, parathyroid and adrenal glands—and part of the pancreas, testes and ovaries. Each gland secretes hormones to signal specific changes in cells affecting body function, development, mineral balance and metabolism. Natural hormones, including those we get from plants and vegetables (phyto-oestrogens), complete their tasks and then break down inside the body. Humans and animals have consumed phyto-oestrogens for millions of years and adapted accordingly. Xeno-oestrogens have been consumed involuntarily for the past 50 years, but at what cost?

In 1987, *Choice* magazine reported high levels of phthalates in cheeses wrapped with PVC film (430 mg/kg in some brands). Following this, the Australian National Health and Medical Research Council (NHMRC) set up a working group to examine phthalate levels in food. Despite the group's toxicologists stressing that toxicology was not a defini-

tive science, and that further data or changed circumstances could lead to entirely different findings, several conclusions were drawn: phthalates migrating into food did not constitute a 'toxic' risk, and there was no need for concern over daily intake levels. Minimising phthalates in food was, however, highly desirable.<sup>2</sup> A number of proposals were suggested regarding labelling regulations for PVC film. Representatives from the plastics industry stressed that self-regulation was still desirable and that proposals to apply warning labels would be resisted.

In 1989, phthalates in PVC mattress covers were linked to cot-death syndrome in studies by Penarth Research International. Subsequent studies refuted Penarth's findings, yet phthalates, particularly DEHP, have been implicated in fatal lung conditions in newborns using PVC ventilators. Parents of newborns are currently advised to place their babies on their backs and remove any plastic (PVC) toys and cot bumpers to reduce the risk of SIDS.

A 1989 meeting of the Australian Committee on Toxicity (COT) considered DEHP for the fourth time, to examine the possibility that DEHP may be responsible for congenital birth defects when combined with chemicals like caffeine. The Committee found there was no reason for concern over human exposure and that no further action was required. Of interest, the United States Food and Drug Administration (FDA) insists on a warning label on any medical products containing DEHP.

In 1992, Australian Standard AS 2070, "Plastics for Food Contact Use", reflected the findings of the NHMRC's 1987 report. AS 2070 contained a warning to food manufacturers of the dangers of biologically active substances (phthalates) migrating into food products via plastic packaging or wrapping materials, including possible "toxic" or "chronic" effects to consumers: "It is essential that the formulation of the plastics materials is such that any migration of substances into the

food from the plastics packaging or wrapping materials is minimised and, if migration occurs, no known toxic hazard will exist to the consumer of the food... Chronic effects...are possible where small quantities of biologically active substances transfer from packaging materials and are ingested in small amounts over a long period of time." AS 2070 came into existence in 1977, yet it contained exactly the same warning as the 1992 Standard.

The World Health Organization (WHO) also published a report on DEHP in 1992. It found DEHP is readily absorbed in soil, is more soluble in blood than water, is highly lipophilic (i.e., loves fat), and is persistent, accumulating in plants and animals. Atmospheric pollution was identified as the major source of contamination, industrial areas generally having the highest levels of DEHP. Blood transfusions and medical treatment using plastic devices were listed as sources of involuntary human exposure to DEHP, the most consistent side-effect of DEHP being testicular atrophy. In 1986 Her Majesty's Stationery Office also reported testicular atrophy in patients undergoing regular dialysis.

A number of questions regarding the types of plastic used in blood bags, intravenous tubing and medical products were recently directed to members of the medical industry. Spokesperson for the Red Cross Blood Bank, Dr Richard Kimber, stated he was unaware of any problem associated with PVC blood bags and suggested contacting the manufacturers.

The multinational Baxter HealthCare, supplier of blood bags

and plastic medical products to Australian hospitals and medical centres, recently stated: "...we [Baxter HealthCare] are not in a position to speak on behalf of the industry" regarding "plastics products for medical use".

Baxter HealthCare suggested I contact the Medical Industry Association of Australia with my questions. The MIAA could not understand Baxter's failure to answer questions relating to the products it manufactures, and, meantime, has not been able to contact Baxter for their statement on these questions:

1) What type of plastic/s is used for: (a) blood packaging, etc.?.; (b) intravenous drip tubing, etc.?.; (c) ventilator tubing and masks, etc.?.

2) Have any tests been carried out on these products (1 a,b,c) to determine if any 'biologically active' substances transfer from packaging, tubing, etc. to patients?

3) Could the findings and conclusions of such tests be made available?

The medical industry is well aware of the migration of DEHP into blood stored in PVC bags. Dr Max Whisson, from the Research and Development Unit of the Australian Red Cross in Western Australia, has published a number of papers on the use of PVC blood bags. Concerned by the use of DEHP, Dr Whisson found its use is based on errors in interpretation of blood cell biology.

DEHP migrates readily into red blood cell platelets, somehow increasing the shelf-life of blood products. Long-term exposure to DEHP in the bloodstream may also be linked to an increased risk of heart attack, as DEHP reduces contractile strength of the heart muscle.

In 1992, WHO recommended that disposal practices for DEHP be improved, that steps be taken to reduce the release of DEHP into the environment, and that medical products that contribute to the body burden of DEHP be scrutinised to reduce exposure.

The UK Ministry of Agriculture, Fisheries and Food (MAFF) found phthalates present in every food sample taken since 1993, including meat, fish, eggs, milk and milk products. MAFF estimated that daily intake of phthalates in adults averaged between 0.8 mg per day and up to 1.6 mg per day. Studies in 1995 found high levels of phthalates in infant formula, potato chips, chocolate bars, margarine, milk products and vegetable oils. Products packaged in paper and board, such as cakes, fats and confectionery, also contained high levels of phthalates. Gravy and vegetable burger mix, biscuits and vegetable fat had high concentrations. Every baby milk formula tested contained phthalates.<sup>3</sup> The most contaminated baby milk had concentrations that gave a total daily intake of 0.023 mg per kg of bodyweight. This is only four times lower than levels shown to reduce sperm-count in rats. Safety levels in humans are normally a minimum of 100 times lower than levels shown to cause harm in animals—not four times.

In 1995, doctors from New York's Strang-Cornell Cancer Research Laboratory suggested that xeno-oestrogens found in plastics and pesticides increased breast cancer rates in women. Women who experience early onset of menstruation, late onset of menopause, who have no children or who do not breastfeed their children are considered to be in higher-risk groups for breast cancer. Breastfeeding has been shown to lower the risk of breast cancer by reducing high oestrogen levels associated with pregnancy. The Nursing Mothers Association voiced its concern about the

**The UK Ministry of Agriculture, Fisheries and Food found phthalates present in every food sample taken since 1993, including meat, fish, eggs, milk and milk products... Every baby milk formula tested contained phthalates.**

lack of public awareness concerning phthalates: "We would be surprised if many mothers were even aware of the potential problems." The Anti-Cancer Council of Victoria has preferred not to comment on phthalates, citing funding concerns.

A new book, *Our Stolen Future*, prompted the plastics industry to hold a seminar to discuss its implications: "*Our Stolen Future* is so dramatic, persuasive and comprehensive, it is likely to become the foundation of dozens of attacks on industrial products and processes... It is a comprehensive review of the potential impact of synthetic chemicals on human health," said an industry handout. A spokesperson for the Plastics and Chemicals Industries Association (PACIA) denied there were any proven serious or long-term health issues associated with phthalates, but stated, "...if there is an issue, it's a potentially serious one." PACIA noted its commitment to programs such as Responsible Care, aimed at improving its environmental performance.

Initiatives such as Responsible Care and the chemical and plastics industries' self-regulation were recently assessed by the Australian Centre for Environmental Law. It noted that the failures of self-regulation far outnumber its successes, and concluded that Responsible Care "...is unlikely to substantially improve...environmental performance of the chemical industry or regain the trust of the public in the industry's integrity".

A CSIRO study, commissioned and financed by PACIA, is due for release on 12th September 1996 [just as we go to press]. The study will undoubtedly side with industry claims, despite the principal researchers' personal misgivings concerning available data. The CSIRO's report will probably show that there is little evi-

dence regarding any 'proven' side-effects of xeno-oestrogens or hormone mimicry.<sup>4</sup> Greenpeace was not asked to contribute to the study's findings and has called CSIRO's independence into question. And when CSIRO researchers are not permitted to speak or confer with other researchers, certain National Socialist policies enforced in pre-World War II Germany spring to mind.

Professor Mark Wahlqvist, head of the Department of Medicine at Monash University and Chairperson of the Australian Nutritional Foundation, expressed his concern: "We know there are naturally occurring oestrogens and xeno-oestrogens in the food chain...the latter being of some concern. Research is required to establish the levels of xeno-oestrogenic compounds in the human food chain and in human tissue, as a matter of priority." Recent studies have shown fish to change sex with long-term exposure to oestrogenic compounds. Phthalates and many other chemicals, such as DDT, 2,4,5-T, 2,4-D, PCBs and dioxins, continue to leave future generations with an unknown legacy.

Matt Ruchel, national toxics coordinator for Greenpeace Australia, believes industry

should stop using phthalates before it's too late: "Regulators and industry must adopt a precautionary approach and seek to eliminate pollution from these chemicals now, rather than wait for conclusive proof of harm...this will mean ceasing the manufacture of PVC plastics...the main sources and use of hormone-disrupting chemicals like phthalates and dioxin. The future of human reproduction and development is too important to us all."

The petrochemical industry insists there is no proof of any links or chronic health risks associated with the use of PVC or its many additives. Meanwhile, Australians, on a per-capita basis, rank

**The petrochemical industry insists there is no proof of any links or chronic health risks associated with the use of PVC or its many additives.**

## PHthalates AND HEALTH

◇ Melbourne's Royal Children's Hospital Poison Advisory Centre did not consider a one-off exposure to oestrogen or oestrogenic compounds to be harmful, but "the exact toxic doses have not been determined". On the subject of phthalates, there was "no data available about possible systemic effects, although irritation to eyes, mucous membranes and skin has been reported".

◇ Figures from the Australian Bureau of Statistics and the Consultative Council on Obstetrics, Paediatric Mortality and Morbidity show the majority of infant deaths under the age of 12 months are associated with endocrine-related disorders, congenital defects, diseases of the nervous system and complications immediately before and after birth.

◇ Victoria's water management authorities and the Environmental Protection Authority do not monitor phthalate levels in water or air samples. Statistics from Victorian Health and Community Services reveal that Melbourne's industrial areas have higher rates of asthma and lung disease. Dr Geraldine Elliott, Executive Director of the Asthma Foundation of Victoria, suggested proper research should be a priority: "Increased awareness and balanced research is a very important process. Availability of known facts concerning various chemicals enables consumers to make up their own minds and reduce their exposure to irritants."

◇ Medical studies have suggested that sperm counts have fallen by up to 50 per cent over the last 50 years in some countries, with testicular cancer rates increasing dramatically in the same period. Several varieties of phthalates, including DEHP, are known testicular toxicants. A recent study on aborted male fetuses found they were already developing testicular cancer in the womb. Testicular cancer rates in agricultural countries also appear to be higher than those in non-agricultural countries. For example, testicular cancer rates in Denmark have risen 300 per cent, while rates in Finland have remained the same. The increase in abnormalities, including undescended testicles and genital malformation, appear to be related.

second only to the Americans in their consumption of PVC products. Our local industry (ICI and Auscon) has actually increased PVC manufacture.

Long-term research into PVC and phthalates would involve millions of dollars—money better spent on anti-cancer research, perhaps. If, as Senator Woods suggests, "there is no immediate risk", what of the risks to future generations?

## Endnotes

<sup>1</sup> DEHP is used in such PVC-based products as acetates, adhesives, adhesive plaster foils, antiperspirants, air filters, automobile tyres, bandages, celluloid (film), carpets, casts, cosmetics, emulsion paints, engineering compounds, eyeglasses, filtration systems, food packaging, garden hose, hearing aids, inks, insect repellents, laminated cloth, lacquers, lubricants, packaging film, perfumes, pesticides, pharmaceuticals, pipes, plasticiser compounds, polyester fibres, protective gloves, PVC, resins, shower curtains, solvents, toys, vacuum pumps, vinyl flooring and upholstery, wallpapers, and wire coatings for electrical cable.

<sup>2</sup> Kraft Foods conducted independent research into phthalates some 15 years ago. Their report was unavailable for scrutiny, however, as "the results were inconclusive".

<sup>3</sup> For the record, major manufacturers of baby milk formula in the UK are Nestlé, Milupa, H. J. Heinz and Cow & Gate and, in Australia, Wyeth, Nestlé, Mead Johnson, H. J. Heinz and Douglas Pharmaceuticals.

<sup>4</sup> The CSIRO (the Australian Commonwealth Scientific and Industrial Research Organisation) has no official policy on phthalates as yet.

## About the Author:

Barry Densley is a researcher and graphic artist who lives in Melbourne, Australia. He dedicates this article to his son, Anscar, and his wife, Cate. He also invites readers to comment on this article.

Barry is currently researching material for a screenplay based around man-made 'flying saucers' and the suppression of associated technology. His interests include the appropriation of German WWII military equipment and personnel upon Germany's capitulation, especially removal to other countries, e.g. Australia, Canada, United States, etc. Anyone with information on WWII German weapons technology, underground bases, merchant raiders, etc., who would like to exchange information, can phone Barry during office hours on (03) 9292 1411, or fax him on (03) 9292 1177. Barry can also be reached via e-mail at: [bdensley@newscorp.com.au](mailto:bdensley@newscorp.com.au)

## References

- Agency for Toxic Substances and Disease Registry (ATSDR), "Public Health Actions and Findings", Congressional Testimony, US Senate, May 1993.
- Ashby, Brady, Elcombe, Elliott, Ishmael, Odain, Tugwood, Kettle and Purchase, *Human and Experimental Toxicology*, vol. 13, supp. 2, 1994.
- *Assault on the Male*, Horizon, BBC TV, 1993.
- Australian Lactation Consultants Association, "Marketing in Australia of infant formulas", May 1992.
- Australian Standards on "Plastics for Food Contact Use" (AS 2070, AS 2400, AS2477, AS 1886, AS 1404, AS 2139, AS 2171, AS 1886, AS2183 and AS 2609), Standards Association of Australia, 1977-1992.
- Barrett, "Phytoestrogens: Friends or Foes?", *Environmental Health Perspectives (EHP)*, vol. 104, no. 5, May 1996, pp. 478-82.
- "Bis(2-ethylhexyl) phthalate" (report), Government of Canada, 1994.
- "Bis(2-ethylhexyl) phthalate", Priority Substances List Assessment Report, Environmental Protection Authority, Canada, 1994.
- *British Medical Journal*, UK, February 1996.
- British Plastics Federation, news release, April 1996.
- British Plastics Federation, "A response to Greenpeace UK's anti-PVC campaign", UK, June 1996.
- Canadian Centre for Occupational Health, "Chemical Evaluation", Canada, May 1996.
- Colburn, Myers and Dumanoski, *Our Stolen Future*, Dutton/Penguin, USA, 1996.
- Colburn, von Sall and Soto, "Developmental Effects of Endocrine Disrupting Chemicals in Wildlife and Humans", *EHP*, vol. 101, October 1993, pp. 378-84.
- Cone, "Battle looms on chemicals that disrupt hormones", *Los Angeles Times*, October 1994.
- Consultative Council on Obstetric and Paediatric Mortality and Morbidity, Annual Report, Australia, 1994.
- "DEHP: di(2-ethylhexyl) phthalate", TOXFAQs, ATSDR, the Internet, May 1993.
- Department of Agriculture, "A Review of Growth Promotant Experiments in Beef Cattle in South Gippsland", Victoria, Australia, 1986.
- Department of Health and Human Services, "Sixth Annual Report on Carcinogens", USA, 1991.
- *Dictionary of Scientific and Technical Terms*, McGraw-Hill, 1978.
- "Di-N-Octyl Phthalate" (report), Government of Canada, 1993.
- Edinburgh, *Global Geocarcinology* (G. M. Howe, ed.), Churchill Livingstone, New York, 1986.
- Environmental Endocrine Effects: An Overview of the State of Scientific Knowledge and Uncertainties", discussion draft, Center for the Study of Environmental Endocrine Effects, Washington, 22 September 1995.
- "Environmental oestrogens: Consequences to human health and wildlife", Institute for Environmental Health (IEH), University of Leicester, UK, 1996.
- Food and Drug Administration, Biocompatibility Guidelines for Medical Devices, USA, 1992.
- Greenpeace, "Phthalates Briefing Sheet and Analytical Report on Phthalate Contamination of Homebush, Sydney", Australia, 1995-1996.
- Greenpeace, "Taking Back Our Stolen Future: Hormone Disruption and PVC Plastic" (report), Australia, April 1996.
- Gunningham, "Environment, Self-regulation and the Chemical Industry: Assessing Responsible Care", Australian Centre for Environmental Law, Australian National University, Canberra, ACT, Australia, 1995.
- Guppy, Whisson, Sabaratnam, Withers and Brand, "Alternative Fuels for Platelet Storage: A Metabolic Study", *Vox Sang*, vol. 59, 1990, pp. 146-152.
- Guppy, Arthur and Whisson, "The Pasteur effect in human platelets: implications for storage and metabolic control", *British Journal of Haematology*, vol. 91, 1995, pp. 752-757.
- Her Majesty's Stationery Office, "Review of the Toxicity of the Esters of Ophthalmic Acid", HMSO, UK, 1986.
- "Hormone-disrupting chemicals on man and the environment.", IEH, University of Leicester, UK, 1996.
- Jobling, *EHP*, vol. 103, 1995.
- Lemonick, "What's wrong with our sperm?", *Time*, 18 March 1996.
- Ministry of Agriculture, Fisheries and Food (MAFF), "Phthalates in Paper and Board Packaging", Food Surveillance Information Sheet 60, UK, 1995.
- MAFF, "Phthalates in food", Food Surveillance Information Sheet 82, UK, 1996.
- MAFF, "Phthalates in infant formula", Food Surveillance Information Sheet 83, UK, 1996.
- "More plastic hazards", *Choice*, September 1987.
- "Statement from the Work Session on Environmental Endocrine-disrupting Chemicals: neural, endocrine and behavioral effects", *EMS*, Washington, May 1996.
- "Milk fears create new food safety crisis", *Guardian*, UK, 28 May 1996.
- National Health and Medical Research Council, "Plasticiser Report", Australia, November 1987.
- "New Wrap", *Choice*, July 1986.
- Nursing Mothers Association Australia (NMAA), "Contaminants in Breastmilk", Lactation Resource Centre, Australia, 1989.
- "Particle spallation and plasticiser (DEHP) release from extracorporeal circuit tubing materials", Department of Medicine, University of Newcastle-upon-Tyne, England, UK, January 1990.
- "Plasticisers in baby food formula", *Daily Mail*, London, 27 May 1996.
- PACIA, "Our Stolen Future" (handout), Australia, June 1996.
- Pinchbeck, "Downward Motility", *Esquire*, January 1996.
- "PoisIndex", database at Royal Melbourne Children's Hospital, Melbourne, Australia, June 1996.
- Raeburn, "From a Silent Spring to Barren Spring", *Business Week*, 18 March 1996.
- Raloff, "The Gender Benders", *Science News*, vol. 145, January 1994, pp. 24-27.
- Raloff, "Pesticides may Challenge Human Immunity", *Science News*, March 1996.
- Reimann, *Patents for Hitler*, Richard Clay and Co. Ltd, Suffolk, England, 1942 (published 1947).
- Ritter, "Teratogenicity studies on di(2-ethylhexyl) phthalate (DEHP), 2-ethylhexanol (2-EHXO), 2-ethylhexanoic acid (2-EHXA) and valproic acid", *Teratology*, vol. 35, 1987, pp. 41-46.
- Royal Commission on New Reproductive Technologies, Government of Canada, 1993.
- Safe, "Environmental and dietary oestrogens and human health: is there a problem?", *EHP*, April 1995.
- Taubes, "Pesticides and Breast Cancer: No Link?", *Science*, vol. 264, 22 April 1994, p. 499.
- Therapeutic Goods Administration Library, Woden, ACT, Australia.
- Rock, Gail (Dr) (letter, Dept of Medicine, University of Ottawa), *Transfusion*, vol. 30, 1990, p. 767.
- "Understanding Infertility: Risk factors Affecting Fertility", *Research Studies*, Minister of Supply and Services, Canada, vol. 7, 1993.
- "Victoria's Health: Second Report on the Health Status of Victorians", HCS, Victoria, Australia, 1995.
- Warhurst, "Hormone-disrupting toxicity", University of Edinburgh, Scotland, May 1996.
- Whisson, Nakhoul, Howman, Niu and Guppy, "Quantitative study of starving platelets in a minimal medium maintenance by acetate or plasma but not by glucose", *Transfusion Medicine*, vol. 3, 1993, pp. 103-113.
- Wise, "Update on Hypoglycaemia", 1975.
- "World scientists list developmental risks from endocrine disruptors", *Water Policy Report*, Global Press, June 1996.
- World Health Organization, "EHC 131: Diethylhexyl Phthalate", Environmental Health Criteria, 1992.
- Woods, Robert (Senator), "Immediate Investigation following UK Baby Milk Scare" (media release), Australian Senate, 28 May 1996.







# REMOTE-VIEWING

## — the ESP of ESPionage —

*We may all have latent psi powers, but our ability to develop them is being blanked out by socially engineered stress, and with the collusion of covert agencies.*

by Turan Rifat © 1996

Paranormal Management Systems  
PO Box 2749  
Brighton, Sussex BN2 2DR, UK  
Telephone: +44 (0)1273 690424  
Web site address:  
<http://www.fastnet.co.uk/pms>

### MILITARY DEVELOPMENT OF REMOTE MIND-CONTROL TECHNOLOGY

Military/intelligence interest in remote-viewing (RV) goes back to at least the 1950s. Remote-viewing—the ability to see things far from one's physical body—was developed during the Cold War to enable security organisations to gain information about top-secret enemy sites in which they had no assets.

The Russians have always been more advanced than their American counterparts in the study and development of RV and biophysical remote mind-control technology (RMCT). This did not go unnoticed by the CIA and the US military, who started experimenting with biophysical RMCT in the 1960s. However, because it proved difficult to control, the Americans concentrated instead on electronic techniques—until quite recently. US military research into RV was implemented with Project *Scangate*, and continued with many different projects including *Grill Flame*, *Center Lane*, *Sunstreak* and *Stargate*.<sup>1</sup>

As a scientist I became fascinated by the implications of RV, for if it really worked it totally upset the paradigm upon which our scientific model of reality is based. The work of Dr Jessica Utts—a Professor of Statistics at Stanford who has scientifically proven that RV phenomena exist<sup>2</sup>—was significant in this respect for it showed that science as we know it is crucially flawed.<sup>3</sup> We have developed atomic energy, yet it is as if we have less knowledge than our cave ancestors about the essential nature of reality. The sceptics rebutted the Utts paper and have denied that any paranormal phenomena could possibly exist.<sup>4</sup> This might be more comfortable for the scientific community, but RMCT is being used more and more by the military/intelligence community.

To mask this, the US military's position on RV was stated by CIA spokesperson David Christian, who accepted that no further official US research into RV was warranted: "We think the intelligence community shouldn't pursue research on this and that it is best left to the private sector..."<sup>5</sup>

Is there a campaign of disinformation to cover up their continued and accelerated study of the subject? Could programmes such as *The Real X-Files* (shown on Channel 4, UK)—created by Jim Schnabel, an alleged CIA operative—be designed to act as red herrings, to mask the US security organisation's true intent? If so, wouldn't the public's interest in this area mean that the privately-run US RV organisations (all headed by 'retired' US security officers), to which the public could turn for training, would have a large number of applicants? This would be useful if the US intelligence community were trawling for undiscovered psi-able people to recruit for a burgeoning RMCT military programme.<sup>6</sup>

### THE SCIENTIFIC BASIS OF REMOTE-VIEWING

This led me to ask whether there could be a scientific basis to RV and RMCT. As a proponent of RV, I knew that it worked.

Joe McMoneagle, a retired US Army intelligence officer—who claims to have left *Stargate* in 1984 with a Legion of Merit award for providing information on 150 targets that was unavailable from other sources—used RV to go into the mind of Shaw Taylor, to see through his eyes, in an experiment carried out on *The Paranormal World of Paul McKenna* (ITV, UK). This method of using RV to enter the brains of other people is called remote sensing (RS). Biophysical RMCT can be considered to have the explanation for how ESP and telepathy work.

I have had many people ask me whether there is information available on the scientific basis of RV. Having looked through the Internet at the web sites purporting to be leaders

in RV technology, I came to the conclusion that either the knowledge base of Western experts was feeble, or most of the *real* information was classified. Most of the leading research done in the US on brain function with respect to *electronic* RMCT is classified. The excellent articles in NEXUS (e.g., vol. 3, no. 3) have covered electronic RMCT in more depth than is available elsewhere, but to my knowledge there has been little scientific discussion of *biophysical* RMCT, so the following is a brief introduction.

The Russians have been the world experts in biophysics since the 1950s. Their research in this area has concentrated on military uses of biophysical field effects and telekinesis (the ability to move objects at a distance), as well as the search for 'psi genes' that promote and mediate RV and the biophysical fields involved in telekinesis. This has led the Russians to study the biological basis of RV.

For RV to work, 'something' must leave the body so that remote locations can be seen. Research seems to indicate that RV uses biophysical field effects to manifest perception outside the body.

The Russians have used all means at their disposal to develop biophysical RMCT—drugs, hypnosis, invasive brain surgery, electronic implant technology and a number of electromagnetic, electrostatic, magnetic and psychotronic means to boost the latent psi abilities of carefully selected psi-able Russians.

There is reason to believe that their research in the biophysical domain became so advanced that they opened doorways to other continuums and themselves fell prey to malevolent forces. US research into these areas will eventually lead the Americans to the same crossroads. Indeed, in a secret underground base they are already experimenting with electronic extradimensional doorways, exposing the US consciousness to incredible levels of extradimensional influences.

It is well known that the physical body is surrounded by a mantle of electromagnetic (EM) energy. The eyes pick up this pho-

tonic emission, though 90 per cent of this information is filtered out in the thalamus, with the remainder fitted into a visual-mental model which we see as reality. Once visual perception can be *unfiltered*, auras can be seen around people.

### EMF-INDUCED CALCIUM EFFLUX EVENTS

The US Government started researching electronic RMCT as a result of early work on the effects of EM radiation on human behaviour.

Microwave stimulation of the brain with extra-low-frequency (ELF) audiograms has been shown to affect brain function for RMCT.<sup>7</sup> This methodology is the basis of US RMCT. However, the EM field around the body can also be affected by other types of EM irradiation, electric fields and magnetic fields.

Dr Ross Adey, formerly of the Brain Research Center at the

University of Southern California, and now at the Loma Linda University Medical School, California, worked on the CIA's infamous *Pandora* project. His research involved inducing of specific behaviour modifications by electromagnetic means, as well as inducing calcium efflux events to interfere with brain function—the so-called "confusion weaponry". (More recently, Dr Adey has been warning against the biological hazards of EM emissions from mobile phones.)

**There is reason to believe that [Russian] research in the biophysical domain became so advanced that they opened doorways to other continuums and themselves fell prey to malevolent forces.**

Dr Adey's research at the Brain Research Center has shown the existence of a biological reaction to EM radiation. This reaction was found to be dependent on the frequency, amplitude and dose of the microwave radiation used.

In the 1980s Dr Adey performed some crucial experiments using microwave carrier-waves modulated with ELF waves to modify brain tissue responses. He carried out experiments with cat brain tissue, showing that the binding of calcium ions to neuronal sites was affected by weak EM fields. These fields were of a frequency and amplitude similar to fields produced in mammalian bodies and detected on electroencephalographs (EEGs).

Dr Adey demonstrated how a 147-megahertz (MHz) field, which at tissue level had an intensity of 0.8 milliwatts per square centimetre, caused an efflux or release of calcium ions from the irradiated brain tissue. This response only occurred when the ELF modulation of the microwave carrier-wave had an amplitude modulated at 6-20 hertz (Hz). The maximum stimulation of the neurones took place at 16 Hz, but to either side of this frequency-range parameter there was no effect.<sup>8</sup>

Microwaves of a similar waveform were used in a US research facility by C. S. Blackman, who worked on the theory underlying the electronic RMCT devices now deployed worldwide. He noted a set of narrow field intensity parameters of microwave irradiation effects that was greatest at 0.75 milliwatts per square centimetre, causing the neurones to efflux calcium to the greatest extent.



Adey repeated Blackman's experiments and confirmed a microwave intensity parametric area of between 0.1 and 1.0 milliwatt per square centimetre, using a 450-MHz microwave carrier-wave amplitude modulated by an ELF of 16 Hz. He found that this set of EM parameters caused the largest calcium efflux in the neurones. When other EM parameters were used, they caused no response.

In comparison, ELF-modulated microwave radiation in the range of 6-20 Hz, at field intensities lower by several orders of magnitude than the above, caused a decrease of calcium ion efflux in the neurones. A useful observation was that the frequency and amplitude of the response of the neuronal brain tissue was the same whether it was stimulated or damped. There was a consistency in the magnitude of the response, i.e., a 10 to 15 per cent increase in calcium ion efflux using the higher intensities, and an identical reduction using the lower intensities described above.

Since the neurones are affected by EM fields, the EM mantle around our bodies—and anything that affects it—will also affect brain function.<sup>9</sup> The mechanism for this is that ELF-modulated microwaves can affect calcium efflux in the neurones, which can affect short- and long-term potentiation of the neurones with a concomitant effect on memory.

### STRATEGIC ELECTRONIC WEAPONRY

It was inevitable that military/intelligence interests would develop electronic RMCT weapons systems. These weapons fall into a number of classes, the simplest being the use of microwaves at low amplitudes, e.g., 10,000 microwatts per square centimetre, to cause local hot-spots in the victim's body areas that have poor circulation, such as the eyes and gall bladder. The microwaves heat up the tissue, which does not have the blood circulation to carry away the excess heat. The victim feels nothing, but sustains acute and chronic illness in these areas. Intelligence organisations in the West use this technology to disable permanently the 'subversive elements' they cannot scare off.

When ELF-modulated microwaves are used, they are keyed to distinctive patterns of brainwaves called preparation sets, which exist for every mechanical gesture the body makes. There are also specific excitation potentials which exist for specific emotional states. Intelligence operatives can induce remote conditioning by creating information-processing effects which can cause excitatory reactions, subliminal stress, behavioural arousal, enhanced suggestibility by inhibition of higher functions, and patterned behaviours. It is alleged that this technology is used by the CIA and MI5 to modify the behaviour of 'high-profile subversives'.

The more advanced electronic RMCT utilises ELF-modulated masers for long-range, penetrative, invasive EM mind-control. Together with Doppler-shifted interrogative RMCT masers, a victim's brain-states can be analysed at a distance—and the 'subversive' can be *modified* at a distance. Developments on this technique, and the use of low-frequency EM radiation to see through walls, have allowed intelligence agencies in the US to make useful inroads on the path to synthetic telepathy.

Much of this research has been funded by the CIA which began this work on electronic mind-control with its *Pandora* project.

This research was used to build devices like RHIC-EDOM (Radio Hypnotic Intracerebral Control - Electronic Dissolution of Memory), which is allegedly used for forced induction of hypnotic trance in the abduction of and experimentation upon civilians by US Government agencies.<sup>10</sup>

### REMOTE-VIEWING AS A BIOPHYSICAL FIELD EFFECT?

My research interest has been in the biological and biophysical basis of paranormal phenomena. Since the body has an intrinsic EM mantle, could this EM field be projected outside the body?

Dr Ross Adey's research has identified a pathway by which EM fields can directly affect the brain. Could information-gleaning by roving biophysical EM field effects be the basis for RV? These EM fields could be picking up information, then transferring it to the brain by the above mechanism. It seems a valid basis for RV. Unfortunately, it is not the whole picture.

Remote-viewing operators can travel to distant star systems, travel backwards and forwards in time, and enter US facilities that are protected by metal Faraday cages and armed with EM flytrap field generators.

All of these phenomena indicate that something not limited by Einstein's special theory of relativity and Maxwell's EM field equations is acting as the carrier for RV.

Perhaps US researchers investigating remote viewers' capabilities have learnt to manipulate EM field effects for their RV experiments using electronic enhancement

of psi effects. This methodology is the basis for US experiments into biological synthetic telepathy—the use of EM fields to boost latent psi-gene activity to the level where it is useful. My research seems to indicate that they are only scratching the surface of the RV envelope.

What is interesting to note from Dr Ross Adey's research is that a 6-20-Hz frequency is needed for neuronal calcium efflux events. 'Normal' people are entrained to function at high beta, which pushes their EEG-measured brainwave frequency above the

20-Hz threshold. This means that they have no contact with neuronal calcium efflux events. If these events are, as I believe, an integral part of RV and other psi operations, the general public will be psi-damped, not exhibiting parapsychological talents to any marked degree.

Alpha training, which teaches people to work in the 7-14 Hz range, seems to open up psi abilities. If neuronal calcium efflux events are crucial to psi operation, we can begin to see a reason why simple techniques of alpha entrainment and biofeedback can bring on paranormal functioning in humans.

Major Ed Dames (Retired) has stated that military remote-viewers operate in theta. This is a brainwave frequency of 4-7 Hz. So it may be that lower frequencies in the 6-20 Hz window are more powerful for psi activity. Since the energy of the EM wave is related to frequency, if we lower the frequency of our brainwaves we can think with less energy and our biophysical RV vehicles are therefore more efficient.

To understand what is really going on beyond the EM bandwidth of RMCT events, we need to reappraise physics. In the early part of this century, Einstein formulated his general theory of relativity which linked the curvature of space-time with gravity. In formulating the field equations to link curvature of space-

**Remote-viewing operators can travel to distant star systems, travel backwards and forwards in time, and enter US facilities that are protected by metal Faraday cages and armed with EM flytrap field generators.**

time with gravity, Einstein found that the energy-momentum tensor (simplistically, the sum total of mass-energy) did not equate to the Ricci tensor (a sort of one-term summary of curvature which varies from point to point). To balance his equation, Einstein had to subtract from the Ricci tensor,  $R$ . As a scientist, I was intrigued by the question of why this should be so. It would seem to indicate that reality is not singular but has a duality. The Einstein tensor only balances when one subtracts the mathematical summation of the curvature of this other reality, from the curvature of physical space.

The dual nature of reality has been written about in many books.<sup>11</sup> Could RV be a biophysical field effect moving in this parallel reality? If so, our knowledge of the nature of reality may be so limited that we are completely blind to this second reality which is contiguous with our own and only makes itself known to us in the quantum realm.

This parallel reality is seen in lucid dreaming and OOBEs (out-of-body experiences) and is glimpsed in daydreaming states. Australian Aborigines have a whole body of knowledge about their Dreamtime reality. Remote-viewers are relearning abilities that our ancestors had direct knowledge of millennia ago.

My research has led me to believe that this 'dreamtime' reality is not electromagnetic in nature, but is composed of a new set of field effects. These field effects are the basis of biophysical, biotronic and bioplasmic phenomena. The electronic RMCT of the US Government mind-control devices and related weapons systems mimics these higher-order field effects.

#### SELECTIVE PRESSURE ON PSI GENES

Remote-viewing would have been of great use to our hunter-gatherer ancestors. Hunters who could find game would have been, by natural selection, more likely to breed. This would mean that any 'psi genes' would have been selected. Throughout our hunter-gatherer past, psi genes would have increased, as those carrying these genes would have been more likely to survive.<sup>12</sup>

With the onset of agriculture, the selective pressure would have ceased to be so important. Consequently, highly developed cultures such as our own would have lost the psi genes to some extent, whilst hunter-gatherers such as the Aborigines of Australia or the Kalahari Bushmen would still have RV capabilities at large in the population. Only cultures which have not persecuted paranormal ability would have kept a high level of psi genes. The North American Indians venerated paranormal abilities, so they would have been a repository of these genes had Europeans not slaughtered them.

It would seem that women in many parts of Europe during the Middle Ages had a number of psi genes removed from their genomes due to the selective pressure from the widespread burning and persecution of 'witches'—indeed, of any woman who showed paranormal ability. This deselection would have made psi genes much rarer, and my research seems to indicate that European men would score significantly better at RMCT than would European women. However, cultures which have *not* persecuted their females may have many women in their populations with enhanced RMCT performance, as there appears to be significant sex-related psi-amplification in females.

The world wars in Europe would have acted on any males in combat as a considerable selective pressure to choose in favour of those individuals carrying psi genes, as in all probability they were more likely to survive. This would mean that the progeny of Europeans who fought in the wars would have more psi genes in the population than they would normally have had, had it been peacetime.

The former Soviet Union has been researching psi genes for decades. KGB operatives were told to pick up people displaying paranormal abilities for use in their vast parapsychological research projects.<sup>13</sup>

The Americans only tacitly began to research the subject in the 1960s 'because the Communists were doing it'. Their research was based on 'new age' phenomena and methodology. This meant the Americans never achieved any great breakthroughs in biophysical field phenomena, hampered as they were by 'new-age thinking' at the expense of scientific methodology.

In 1995 the US security establishment decided to take a new interest in biophysical RMCT. This meant that the CIA had to release disinformation that purported to state that the Americans had given up this research—even though it worked!

From our research, it does seem that some people can display significant RV capabilities. Indeed, people who do RV courses

could have psi genes in their genomes that affect their ability to view remotely. This would seem to indicate that not all the psi genes have been deselected from the population in mankind's long history. Interestingly, the magazine *Fortune* has stated that the 'top 500' CEOs have greater-than-normal psi-intuition and gut-feeling, symptomatic, precognitive reactions.

My research seems to indicate that there are primary and secondary psi genes. Primary psi genes are those that give enhanced RMCT capability by the specific nature of the proteins

they code for, which act as biophysical batteries, and other more obscure phenomena which are involved with biophysical processing, storage and utilisation. The secondary psi genes are those that facilitate biophysical integration with the organism and which code for richer and higher-function neural networks to interface with the biophysical energy.

It also appears that some peoples' bodies act as natural psychotronic generators and can store psi energy.<sup>14</sup>

#### SWITCHING ON LATENT REMOTE-VIEWING ABILITIES

The high basal stress levels of Western man release a torrent of neurohormonal and electrical stimuli that appear to switch off the psi genes. Instead, this overstimulation would seem to switch on the oncogenes that cause cancer. This also means that paranormal abilities are rare in the general population and lack the repeatability needed for scientific verification.

Since stress interferes with the mechanism of RV, it is vital that the stress neurohormones and electrical overstimulation that switch off psi genes be lowered to the point where they cannot inhibit RV activity.

It is necessary to learn new mental software (memes) to run remote-viewing programmes to increase the signal-to-noise ratio of psi phenomena.<sup>15</sup> Learning new memes to switch off the negative-feedback cycle that keeps people in a state of anxiety is also

**...women in many parts of Europe during the Middle Ages had a number of psi genes removed from their genomes due to the selective pressure from the widespread burning and persecution of 'witches'...**

vital to initiating RV. Simple new habits and software, that people can use at work to inculcate RV ability, also amplify the process of RV initiation. Built into this methodology are techniques to free-up biophysical energy and develop RV abilities. This is done with the knowledge that people expend much of their biophysical energy at work.

An effective system of RV training must bring in people's working habits and training, to show them that enhancing their effectiveness at work by use of psi-enabling memes will invariably open up paranormal abilities. The rationale behind this is that if you are more effective at work, you have more biophysical energy left over at the end of the day for use in building an RV biophysical body!

By including your normal day-to-day work memes and incorporating them into RV training, people will automatically be practising their RMCT. The net effect of this is tremendous improvement in RV abilities.

The 'cinema method' of clearing one's mind, using RV as the moving pictures, is a fundamental next step. When watching the cinema screen, we all stop talking to ourselves. This switches off the internal dialogue, the incessant mental conversation that we have inside our heads.<sup>16</sup> Mental silence is the second major initiator of RV. The first is habitual relaxation, which can be achieved with the use of psi-enabling stress-management techniques.

Clearing the mind by focussing directed attention on RV is the most powerful way to develop biophysical RMCT. Directed attention is the guided use of perception for the study of RV. Once directed attention has been set up, it can be used for remote-viewing of distant locations. First practice is on known locations; then on more obscure sights. (A discussion of ways to improve RV abilities is covered at length on my web site.)

Another factor I looked at was the phenomenon of being able to be aware of two places at once. Physical perception and RV can be practised at the same time. This has dramatic implications, for it means that our brains and our biophysical field effects can have awareness separate from one another.

#### REDESIGNING OUR OWN DNA

Dr Gerald Edelman, a leading neurophysiologist, has formulated the theory of neural Darwinism. This postulates that neurones compete with each other by natural selection and, in the process, neuronal group selection forms neural networks which have the capability of primary consciousness. As the process is iterated, high-order consciousness develops, leading to sapience in man.<sup>17</sup>

Connecting this work with that of Dr Ross Adey, there is an indication that the brain can think without biophysical field effects; but these field effects, through their link with calcium efflux-modulated neuronal potentiation events, can interact in a synergistic manner.

Research into RV and OOBs indicates that biophysical field effects also have high-

order consciousness.<sup>18</sup> The mechanism of high-order consciousness in biophysical field effects is derived from similar processes of Darwinian selection in morphogenetic fields.<sup>19</sup>

It is known by morphogenetic development researchers that the human genome does not contain enough information to turn the blastocyst (the small clump of fertilised cells) into an embryo. Morphogenetic field effects are needed to switch on specific gene groupings depending on their position in the blastocyst. These biophysical morphogenetic fields switch on specific genes and turn off other genes, all based upon their location in space-time.

It was a profound revelation when I realised that the biophysical fields contain large amounts of information not held in the genome and, further to this, that the biophysical fields can control gene expression.

It then did not take me long to realise that a natural consequence of RMCT was the development in RV practitioners of an evolution in their morphogenetic fields. Like the neurones affected by neural Darwinism, morphogenetic fields could evolve through primary consciousness to high-order consciousness. This would enable powerful RV abilities but, more importantly, it could enable psi-able operators to switch their genes on and off. The health and gerontology implications of this are far-reaching.

I have developed a technique which I call paranormal psychoneural immunology—the use of RMCT to raise morphogenetic field effects to high-order consciousness. And with the discovery that a gene can change naturally into a normal version in a patient suffering from a lethal genetic disease, it appears that our genome can be changed *in vivo*.<sup>20</sup>

RMCT, then, in its guise of paranormal psychoneural immunology, can be used to change our own genome. It would also seem that the use of theta states can enable psi-able operators to rewrite their own DNA.

**This would enable powerful RV abilities but, more importantly, it could enable psi-able operators to switch their genes on and off. The health and gerontology implications of this are far-reaching.**

#### Still Life

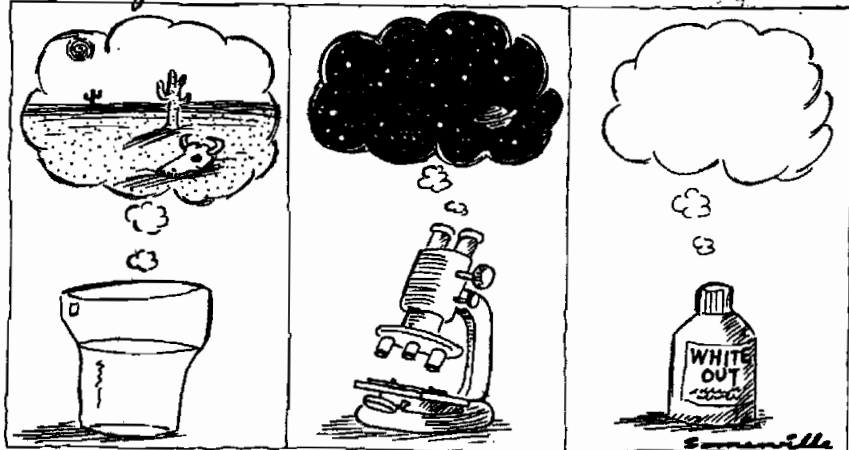

I am using this line of research in an attempt to increase the telomeres on the ends of my chromosomes by selective stimulation of telomerase enzymes in the nuclei.

Since telomere loss is associated with ageing, this may boost longevity without the risks associated with the US drug rejuvenation programmes being developed by American corporations for the NWO super-rich.

### REMOTE-INFLUENCING

To conclude this introduction to the science of biophysical RMCT, a technique known as sleep-wake hypnosis can enable a hypnotist to transfer hypnotic commands telepathically to a subject, whether a few feet or even a thousand miles away.

A Ukrainian, Albert Ignatenko, demonstrated on the TV show, *The Paranormal World of Paul McKenna*, that he could raise or lower the pulse rate of people who were at a remote location. This was a dramatic demonstration of remote-influencing (RI), which is the basis of hypnosis.

My research would seem to indicate that the psi-able operator is capable of affecting the neuronal calcium efflux of another person through remote-viewing, rather like the US National Security Agency's electronic microwave mind-control machines.

The use of RI could therefore be used to affect, for instance, the money markets by working on the brains of the market-makers. Since these biophysical field effects reside in us all, it would seem probable that RI will be seen as a threat to the New World Order ruling class.

### PRIVACY AND SURVEILLANCE

With the growth of electronic means of spying on the public, privacy is something that is vanishing completely. For example, my phone and flat are bugged and MI5 operatives regularly search my flat when I am out. The whole of Brighton is covered by cameras linked to the police station, which is a major node in the UK underground command centre structure.

E-mail and faxes are interfered with and monitored, and the web sites that go against US policies are being closed down by frightened Americans.

In this context, RV/RMCT can be seen as a way that the public can put the authorities under surveillance. Since the US and UK governments are deploying electronic RMCT against internal 'subversives', I would find it ironic if the public's use of biophysical RMCT were directed at NWO personnel and their leadership.

As more people use RV, the technique will become more effective.<sup>21</sup> This means that the authorities will try to restrict advanced information about RV and RI as carried out by Paranormal Management Systems and other non-military groups. And with the burgeoning of RV/RI companies run by 'retired' US military personnel, one can be sure that effective know-how will be kept out of the public domain.

PMS offers RV courses that can enable the public to put the authorities under the spotlight. As a caveat, if I were to receive complaints from irate members of the public about infringements to their privacy by PMS-trained people, I would have to close the facility. A proper self-regulatory procedure is a must in this new field of RMCT.

At present, biophysical RMCT is not legislated against and, in any case, the Russian military have almost exclusive use of it.

### A REMOTE-CONTROLLED FUTURE?

The ability of the RV attention to affect the body, and the bodies of other people, could have tremendous implications for healing and for the health of nations.<sup>22</sup> Some aspects of alternative healing can be thought of as a crude, common usage of RI, as the RI effect is the scientific basis of mind-over-matter phenomena. However, the forthcoming European Union 'bans' on some alternative therapies, vitamins and herbal remedies may just be precursors of what's to come.

In the future it may be illegal to think in anything but beta, with only a select few authorised to work in psi-enabling theta. The rising tension in the world, media fearmongering and the mind-deadening effect of TV may be coincidental, but, yet again, perhaps they may not...

The science and technology of remote viewing and mind-control are still relatively young, but they may well prove to be key agents in the affairs of the 21st century. ∞

### Endnotes

- <sup>1</sup>(a) 600-plus Internet references on alta vista;
- (b) Adams, James, "Day of the Pentagon Mindbenders", *The Sunday Times*, 3 December 1995;
- (c) Anderson, Jack and Michael Binstein, "Psychic Spies have a Home at the CIA", United Features Syndicate, 1 November 1995;
- (d) Fleming, Michael, "Psychic Soldier Sells his Bizarre Tale to Hollywood", *Variety*, November 1995;
- (e) Rickard, Bob, "From Russia with Anxiety", *Fortean Times*, June 1996;
- (f) Vistica, Gregory, "Psychics and Spooks", *Newsweek*, 11 December 1995;
- (g) Wolf, Jim, "Psychic Power Real, but Not Good for Spying", CIA says", Reuter, 28 November 1995;
- <sup>2</sup> *The Journal of Scientific Exploration*, Stanford, USA, vol. 10, no. 1, pp. 1-III. Dr Jessica Utts carried out a statistical analysis on the results of the US RV programme. Her results confirmed a greater-than-chance effect—be it a small effect—which proved that RV exists.
- <sup>3</sup> Beloff, John (Dr), "ESP Fact Sheet" (the work of the Society of Psychical Research on RV), Psychology Department, University of Edinburgh, Scotland.
- <sup>4</sup> Refer to the Internet for mention of Dr Ray

**A Ukrainian, Albert Ignatenko, demonstrated on the TV show, *The Paranormal World of Paul McKenna*, that he could raise or lower the pulse rate of people who were at a remote location.**

Hyman and his rebuttal of RV, which has just been released.

<sup>5</sup> Wolf, *ibid*.

<sup>6</sup> Refer to the Internet for list of US RV companies. Two companies among the premier US RV organisations are Psi Tech, headed by Major Ed Dames (Ret.), and Problems>Solutions>Innovations, run by Lyn Buchanan.

<sup>7</sup> Keith, Jim (ed.), *Secret and Suppressed*, Feral House, Portland, Oregon, USA, 1993. This contains an excellent chapter on US electronic RMCT and the unpleasant effects it can cause.

<sup>8</sup> Adey, Ross W., "Spectral Analysis of Low Frequency Components in the Electrical Activity of the Hippocampus During Learning", *Electroencephalography and Clinical Neurophysiology*, vol. 23, 1967;

—, "The Influences of Impressed Electrical Fields at EEG Frequencies on Brain and Behaviour", in *Behaviour and Brain Electrical Activity* (N. Burch and H. I. Altshuler, eds.), Plenum Press, 1975;

—, "Effects of Modulated Very High Frequency Fields on Specific Brain Rhythms in Cats", *Brain Research*, vol. 58, 1978;

—, "Neurophysiologic Effects of Radiofrequency and Microwave Radiation", *Bulletin of the New York Academy of Medicine*, vol. 55, no. 11, December 1979.

<sup>9</sup> "The healing face of electromagnetic fields", *Electronics World and Wireless World*, 1993.

<sup>10</sup> King, Jon, "UFO Reality, No. 3", document from *The Real X-Files* television documentary.

<sup>11</sup>(a) Harpur, Patric, *Daimonic Reality*, Viking Press, 1995;

(b) Castaneda, Carlos, *The Fire From Within*, 1984.

<sup>12</sup> Dennett, Daniel, *Darwin's Dangerous Idea*, Simon and Schuster, 1995.

Continued on page 88







# Danny Casolaro vs the 'Octopus' Conspirators

*Casolaro  
uncovered a  
secret network  
whose sphere of  
influence extends  
over everything  
from computer  
software piracy to  
alien hardware  
conspiracy.*

*His research cost  
him his life.*

*Part 1*

by Kenn Thomas © 1996

Editor/Publisher  
Steamshovel Press  
PO Box 23715  
St. Louis, Missouri 63121, USA  
Web site address:  
<http://www.umsl.edu/~skthoma>

**T**he *Octopus* was writer Danny Casolaro's name for a handful of spooks and power-brokers in the intelligence community who had manipulated public events as wide-ranging as the 1980 "October Surprise" pay-off—which may have cost Jimmy Carter the presidency—and the BCCI banking scandal of the early 1990s.

Like tentacles of his metaphoric sea creature, the slashes found in each wrist of Casolaro's dead body in a Martinsburg, West Virginia hotel in August 1991 pulled him down into oblivion. Casolaro's murder or suicide ended his investigation into the power cabal whose involvement in a list of notorious contemporary political crimes he had hoped to document in his book. Perhaps Casolaro had erred in changing the book's title from *Behold, A Pale Horse*, taken from the biblical admonition, "Behold a pale horse; its rider's name was Death..." (Rev. 6)

Under the new title, *The Octopus*, Danny Casolaro had focussed the manuscript on many connected crimes. It included information on Contra War chemical and biowarfare weapons developed on the tribal lands of the Cabazon Indians of Indio, California—weapons possibly used in the 23rd October 1983 blast at a compound in Beirut that left over 300 American and French military personnel dead. His research also looked at bizarre murders among the Cabazon Indians involving administrators of the tribal land; the privatisation of CIA dirty tricks through the notorious Wackenhut security firm—policemen for both the Cabazons and the mysterious Area 51, home of secret spy planes and rumoured UFOs; Vietnam MIAs; corruption at Hughes Aircraft; the human genome project; even the Illuminati secret societies of the 18th century—the list was quite long.

To his friends, Danny Casolaro was, above all else, the ultimate nice guy. He came from a well-to-do background in McLean, Virginia, a hub of the intelligence community that preoccupied his adult attention. His father had been a successful obstetrician. Although his Italian Catholic family experienced its share of tragedies (a congenital heart defect took one of Danny's five siblings, an infant; an older sister died of a drug overdose in Haight-Ashbury), Danny grew up with the good things in life. By all reports he was a congenial, open-minded and trusting soul with few serious worries. At age 20 he left Provident College to search for treasures of the Incas in Ecuador. When he returned, he settled into a marriage that lasted 13 years and produced one son, Trey (J. Daniel Casolaro III). He lived in a US\$400,000 home on three acres in Fairfax City, Virginia, where he kept horses. He played the piano. His literary tastes ran along the lines of Jack Kerouac and the Beats. He was an Elvis Costello fan.

Danny Casolaro had achieved only a modest success in his chosen profession of writing, however. The magazines and tabloids he wrote for were as varied as his research: *Washington Crime News Service*; *Home and Auto*; *Providence Journal*; *Washington Star*; the *National Enquirer*; the *Globe*. His published books, seemingly towering triumphs for a novice writer, had not provided him much in the way of financial rewards. His novel, *The Ice King*, a Hemingway-esque novel of mountain-climbing, had been published by a vanity press. He also published a short-story collection, *Makes Me Think of Tall Green Grass*, and worked on two films, *Rain For A Dusty Summer* and *To Fly Without Wings*, the latter narrated by Orson Welles. According to one source, "Danny wasn't an investigative reporter. He was a poet."<sup>1</sup>

Maybe so, but of all the things the informant (whom Danny Casolaro went to meet the night before his death) could have shared with him, it seems least likely that it was poetry. The first piece of Casolaro's life to pass into conspiracy lore was that this informant may have supplied him with the last bit of evidence he needed to prove the existence of his Octopus cabal.

Just prior to leaving for Martinsburg, Casolaro had warned his brother, "If anything happens to me, don't believe it's an accident." According to friends and family, little in Casolaro's disposition or behaviour could have led him to suicide. The gashes in his wrists were too deep to have been self-inflicted. After the discovery of his body, the rush to perform the autopsy—without the consent of family—and the quick cleaning of the murder site increased suspicions.

Something in Casolaro's Octopus research quite likely led to his murder. Which aspect of the research could have been that important?

After a brief return to college, Danny Casolaro picked up stringer work for various tabloids and magazines and eventually went to work for *Computer Age Publications*, which reported daily on the personal computer trade. Casolaro stayed on that job for 10 years, eventually becoming part-owner. He sold his stake in the company in 1990, but in a way that had been a disappointment as well. Friends said that he had vastly underestimated the value of the newsletter and had sold it for far less than it was worth.<sup>1</sup>

In early 1990 Danny Casolaro was on the make for a new beginning, but it did not take him far from the computer industry he seemingly wanted to leave behind. He was looking for a great story, something he could sink his teeth into, something that might catapult him toward the monetary rewards he had hoped for.

A friend named Terry Miller, a fellow-worker in the computer magazine business, suggested he might look into a developing scandal involving software designed by a company called Inslaw, the Institute for Law and Social Research. After a discussion with one of the company's founders, William Hamilton, who described the basic outline of the story, Casolaro felt like this might be just the project.

### INSLAW'S "PROMIS"

The Inslaw case began in 1982 when the US Justice Department granted William Hamilton's Inslaw company US\$10 million over three years to adapt a computer program to the needs of US attorneys in tracking criminal cases from office to office. The program was called Prosecutor's Management Information System, or PROMIS.

As Hamilton (a former member of the super-secret National Security Agency) explained, he and his wife Nancy had developed PROMIS with funding from the government's Law Enforcement Assistance Administration. After the LEAA funding was phased out at the end of the Carter administration, the Hamiltons converted Inslaw into a for-profit business. This had all been done in a straightforward manner with the government's knowledge and approval. Hamilton had sent a letter to the Department of Justice requesting they waive any rights to the enhanced version of PROMIS. On 11th August 1982, a lawyer for the Department responded, verifying that Inslaw had the rights to any privately funded enhancements added to the public domain version of PROMIS.

The PROMIS program was being developed for the purpose of keeping track of individuals being pursued or prosecuted by the Justice Department. It included the vital capability, if coded correctly, of interfacing with other databases without having to be reprogrammed. This provided the government with an ominous kind of computer microscope for the long-term monitoring of individuals. As Hamilton explained more, no doubt the pot-boiler possibilities seemed apparent to Danny Casolaro. He realised that the PROMIS software was the Maltese Falcon of a conspiracy web into which Hamilton had fallen.

Hamilton made it clear to the computer-savvy Casolaro that the enhancements he had made to PROMIS were not minor. Early enhancements enabled the software to be run on other, less-powerful computer systems than the original, including IBM, Wang, Burroughs and Prime; later enhancements—the ones taken by Justice—allowed it to run on a DEC VAX mini-computer.<sup>2</sup>

If Hamilton sounded bitter when he talked about the deal that he had struck with the government, he had every reason. The 1982 agreement with the Justice Department was intended to put PROMIS in the 20 largest prosecutors' offices in the US, with modifications on the program to be tailored for 74 smaller department offices. According to Hamilton, this would have been just the beginning of PROMIS's applications. He estimated that the demand for the software eventually might exceed US\$5 billion. Instead of that watershed business, Hamilton launched into a long-running legal battle which continues to this day.

The problems began after Inslaw delivered the modified PROMIS to the Justice Department. First, payments to the Hamiltons were suspended, then the Department

accused Inslaw of overcharging. By February 1985, the Justice Department had withheld almost US\$2 million from Inslaw. When it became obvious that the Justice Department was not going to honour its contract, the company's attorney, former US Attorney-General Elliot Richardson, renowned for his role in the Watergate scandal, advised the Hamiltons to sue. Richardson was one of the few people to emerge from the Watergate days as a man of integrity, having lost his job for refusing to fire Special Prosecutor Archibald Cox at Richard Nixon's direction.

The Hamiltons did sue, and in 1987 Judge George Bason ruled favourably for Inslaw—a ruling that ultimately led to Bason's coerced early removal from the bench. Federal District Court Judge William Bryant upheld Bason's decision, however, after an appeal by the Justice Department, and the Supreme Court denied review in October 1991. No judgement was ever issued exonerating the Justice Department from its actions in the Inslaw matter.

In fact, two congressional committees that also looked into the Inslaw case—Sam Nunn's Senate Permanent Subcommittee on Investigations and Jack Brooks' House Judiciary Committee—concurred with Bason, the latter noting "a full, open investigation of the Inslaw allegations of a high-level conspiracy within the Department to steal enhanced PROMIS software to benefit friends and associates of former Attorney-General Meese, including Dr



Danny Casolaro

Earl Brian." Ancillary to this last conclusion was a recommendation for an investigation into Danny Casolaro's death.<sup>3</sup>

Richardson would ultimately call for a special prosecutor for the Inslaw case. "When the Watergate special prosecutor began his inquiry," Richardson remarked, "indications of the President's involvement were not as strong as those that now point to a widespread conspiracy implicating lesser government officials in the theft of Inslaw's technology."<sup>4</sup>

Attorney General William Barr did appoint a retired Federal Judge, Nicholas J. Bua, as special prosecutor in November 1991. Incredibly, Bua cleared the Justice Department—the office for which he worked—of wrongdoing in the affair. Not mentioned in the report was the US\$25 million that Bua had offered Elliot Richardson to settle the case—more than triple the amount awarded in the first Federal ruling for Inslaw. Bua made the offer in a December 1992 phone call to Richardson and, according to Richardson, they had at least two follow-up calls about it.<sup>5</sup>

Inslaw is now back in court, having won a new trial through a 1995 Congressional Reference Resolution. "Inslaw, Inc. vs the United States and the United States Department of Justice" is scheduled for a three-week trial to begin on 4th September 1996 in Washington's US Federal Court of Claims. Inslaw owners Bill and Nancy Hamilton are represented by the Atlanta law firm of Pope, McGlammery, Kilpatrick and Morrison, which has advised them not to give interviews about the litigation—advice they have honoured.

#### MICHAEL RICONOSCIUTO

Jeff Steinberg, an aide to conspiracy theorist and perennial presidential candidate Lyndon Larouche, had originally put Bill Hamilton in touch with Michael James Riconosciuto, a 44-year-old denizen of the shadowy world of covert operatives.

Riconosciuto first called Hamilton on 18th May 1990 and talked with him for two and a half hours, spinning a gossamer of connections that added startling new dimensions to the Inslaw case.<sup>6</sup> Riconosciuto, in hundreds of collect telephone calls to Hamilton, revealed inside knowledge of the government conspiracy to steal PROMIS from the Hamiltons. He stunned Hamilton further when he told him that he had personally modified the PROMIS software when he was research director of a joint venture of the Cabazon Indian tribe of Indio, California, and the nation's third-largest private security firm, Wackenhut.

Riconosciuto revealed that part of his job in the modification of the software had been to create a "back-door access" for spying into the files of its users. These users included Great Britain, Canada, South Korea, Japan, Jordan, Israel, Egypt and Iraq (Bill Hamilton tallied the figure at "as many as 88 countries"), and they used the software in such activities as the tracking of terrorists.

According to Riconosciuto, Attorney General Edwin Meese had provided PROMIS to Dr Earl Brian and Peter Videnieks from the Department of Justice, who then supervised the Cabazon/Wackenhut project to copy the program.

The theft of PROMIS, according to Riconosciuto, wasn't all that was going on at the Cabazon Indian Reservation. The

Cabazon/Wackenhut venture included the production of advanced weaponry including biological weapons and fuel-air explosives (FAX)—a new technology supposedly the equal of some nuclear weapons in explosive power. Riconosciuto claimed to have been involved in the production of the fuel-air explosives in collaboration with Gerald Bull, of Space Research Corporation, an arms dealer who designed the "supergun" and was murdered in Brussels, Belgium in 1990.<sup>7</sup>

Riconosciuto had more bombshells to drop on an eager Hamilton. He maintained that Meese had provided Brian with PROMIS as a pay-off on a favour. Riconosciuto made the dramatic allegation that, in 1980, William Casey, outside counsel to Wackenhut prior to his work in the Reagan administration, had hired him and Brian to facilitate the October Surprise (in which the Reagan administration allegedly paid the Iranians *not* to release American hostages until after Reagan's election) and pay the Iranians US\$40 million in bribes. The PROMIS software, so Riconosciuto said, was Brian's payment for his participation in the October Surprise.

Shortly after he was contacted by Riconosciuto, Hamilton told Danny Casolaro about his new source. By late 1990, friends say, Casolaro was talking of almost nothing else. He immediately set about investigating this new informant's background, but what he learned only complicated the matter.

Casolaro's investigation showed that Riconosciuto had been a gifted child whose science projects, including the construction of an argon laser, had enabled him to work as a research assistant to Dr Arthur Schalow, the Nobel laureate. Other things in Riconosciuto's past had a shadier aspect. After

leaving Stanford University, he migrated to Haight-Ashbury in San Francisco, where he went to work on an underground newspaper. He told Casolaro that he had acquired some photos which showed a narcotics agent having sex with an under-age girl; and because the newspaper had published them, the narc framed Riconosciuto on drug charges. In 1973 he was sent to prison for two years for manufacturing psychedelic drugs.

Casolaro, however, did not buy Riconosciuto's statement that he had been innocent of the drug charges. In his notes Casolaro states flatly, "Mike sold dope through Phyllis." Phyllis remains unidentified.

Casolaro also told Bill Hamilton he didn't totally buy into Riconosciuto's wild stories. It suited Casolaro that Riconosciuto's complete credibility, at least for the moment, be overlooked because he did offer a valuable commodity: leads to follow.

#### WILD RUMOURS

The facts that Casolaro investigated were astounding enough, but the rumours were out of this world. Rumour had it, for instance, that the Cabazons belonged to worldwide "Reservation Operations", run on native lands by "the Enterprise" and Wackenhut under the project name "Yellow Lodge".<sup>8</sup> Yellow Lodge allegedly produced advanced warfare projects, including



Michael Riconosciuto

parthenogenic viruses co-engineered with Stormont Labs in Woodland, California. Stormont Labs later even acknowledged that it had had discussions with Wackenhut concerning biological weapons.<sup>9</sup>

Again according to rumour, Yellow Lodge ran operations on Jicarilla Apache lands and other Indian reservations, including a centre called "D6", located in Dulce, New Mexico. UFO enthusiasts identify this location as the site of a huge underground joint human/alien base. Others believe the alien base story to be government disinformation intended to confuse the real nature of the Dulce operation.<sup>10</sup>

In his notes Casolaro mentions "MJ-12—Extraterrestrial", alleged by many in the UFO research spectrum to be a super-secret US military group charged with signing a non-aggression pact with space aliens.<sup>11</sup> He also mentions "Area #51" and "Pine Gap".

Area #51 (Area 51), of course, is a military test site in Nevada for advanced aerial weaponry. Although only through a recent job-hazards lawsuit has the Air Force begun to admit to the existence of the base, Area 51 has long been known as the staging ground for the U2 spy plane and the SR71 *Blackbird*, and is much-rumoured as the home of the post-Stealth marvel, the *Aurora*. In 1989, someone named Bob Lazar went public with claims that he had worked at Area 51, taking apart and reverse-engineering alien spacecraft. Although even UFO sceptics acknowledge consistencies in his stories, Lazar's efforts at documenting his credentials and work history have met with some doubt.<sup>12</sup>

Pine Gap is the top-secret underground American base located near Alice Springs in Australia, officially known as the Joint Defence Space Research Facility.<sup>13</sup> Pine Gap allegedly serves as the central American base for the monitoring of spy satellites and interception and decoding of various forms of broadcast communications between foreign powers unfriendly to the US. Pine Gap was built in 1968, ostensibly as a means of sharing space program

data with the Australians. Opposition to the base grew as it became clearer that it had a more prosaic purpose: espionage.

In his 1987 book, *The Crimes of Patriots*, author Jonathan Kwitny demonstrates that CIA manipulation led to the early end in Australia of the administration of Labor Party Prime Minister Gough Whitlam, in part because of his opposition to Pine Gap. Indeed, Whitlam was roused after his public complaints about intelligence agency deceptions over the tragic US policy in East Timor, and the CIA's funding of Australia's right-wing Country Party [now the National Party of Australia]. By a quirk of Australia's Constitution, Whitlam was not driven from office by an election but was removed by a governor-general he had appointed—one who had strong ties to the CIA.<sup>14</sup>

No doubt the paranoia about this destabilisation of the US ally down-under fuelled other rumours among locals about the underground Pine Gap base involving alien/government collaboration<sup>15</sup>—rumours to which Danny Casolaro was privy.

One early page of Casolaro's notes seemingly tied together Area 51, Pine Gap, a small Pennsylvania town called Tonoma, and possibly one of its citizens—someone named Fred Dick. The authors of the new book on Casolaro (*The Octopus*) despatched an investigator to "Tonoma, PA", in the notes, but failed to find Dick even after placing a classified in the local newspaper nor any indication of what

may have linked him to the two mysterious military bases.<sup>16</sup> Buried in notes written much later, however, were references to "Tonomopah, Nevada, near Area 51". Fred Dick, however, remains a mystery.

Casolaro's interest in the UFO world may have begun with Michael Riconosciuto. Riconosciuto had a proclivity for flights of flying-saucer fancy going back at least a generation. After Casolaro's death, he told one computer magazine that Casolaro had learned nothing more than what one of two intelligence agency factions wanted him to know in order to embarrass the other faction. One faction was called "Aquarius" and had a leadership sub-group called "MJ-12".<sup>17</sup> Riconosciuto even told one writer that he had witnessed the autopsy of an alien body. The writer concluded that Riconosciuto "would have told anyone anything to get out of prison".<sup>18</sup>

Rumours also had it that Riconosciuto had worked for Lear Aircraft in Reno, Nevada. This connected him to both Bill Lear, creator of the Lear jet and often claimed by UFO buffs as having done research on anti-gravity for the government, as well as John Lear, a former CIA pilot who also hit the UFO circuit with tales of saucers and aliens in cahoots with the US Government.

John Lear and Bob Lazar comprise a faction within the ufological sub-culture that still maintains a regular presence at its gatherings. Other members of this nexus have included the redoubtable William Cooper, whose 1991 book, *Behold A Pale Horse*, shared the title of the first draft of

**In his notes Casolaro mentions "MJ-12—Extraterrestrial", alleged by many in the UFO research spectrum to be a super-secret US military group charged with signing a non-aggression pact with space aliens. He also mentions "Area #51" and "Pine Gap".**

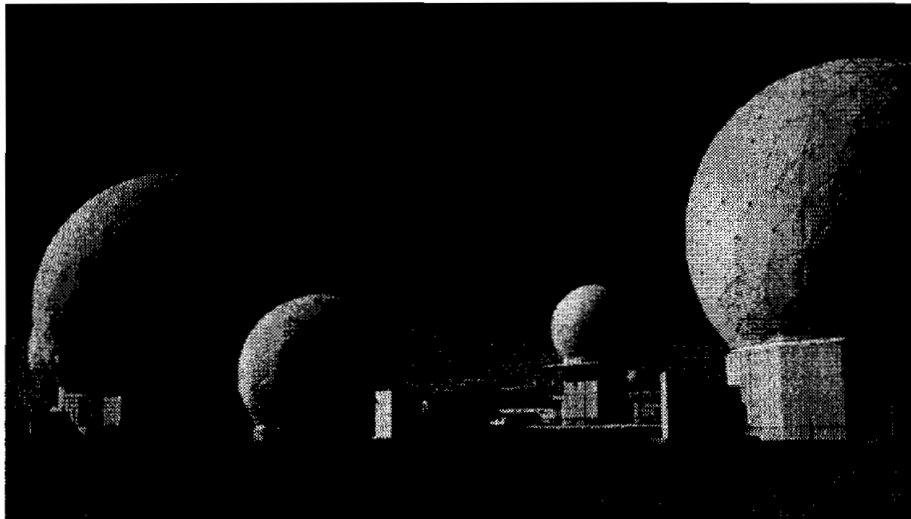

Close-up of radomes at the Joint Defence Space Research Facility, Pine Gap, near Alice Springs, central Australia. (Source: Department of Defence, Canberra, ACT, Australia)

Casolaro's manuscript and became a cult classic for its examination of Area 51, its reprinting of the anti-Semitic *Protocols of the Elders of Zion*, and its claim that JFK was shot by the driver of his car in the presidential motorcade. To a lesser extent the nexus also included Gordon Novel, by rumour and confession a minor player in the Kennedy assassination and the Watergate scandal. Some have suggested that the bizarre tales of extraterrestrials coming from this nexus serve as disinformation to deflect attention away from serious issues such as gun-running and black-project weapons development.<sup>19</sup>

Riconosciuto had his own intergenerational connection to the UFO lore and his own link to the Kennedy assassination. His father, Marshall, had been a business associate of Fred Crisman, a man involved in one of the earliest UFO incidents that followed pilot Kenneth Arnold's famed flying discs over Mt Rainier in 1947—something called "the Maury Island incident".<sup>20</sup>

Arnold, in fact, investigated claims by Crisman and another man named Harold Dahl that Dahl, his son, his dog and two others witnessed six saucers as the crew boated around the harbour at Puget Sound, along the shore of Maury Island. This was near where Casolaro spent time years later looking for a tape that "Danger Man" Riconosciuto had tossed, which supposedly documented threats he had received from Peter Videnieks of the US Justice Department. Dahl's child was burned and the dog killed when one of the saucers spewed metallic debris on the boat.

Crisman and Dahl mailed metal fragments of the debris to *Amazing Stories* editor Ray Palmer, who hired Kenneth Arnold himself to investigate. Confused by what he was hearing from

Crisman and Dahl, Arnold called in two Air Force Intelligence officers. They conducted some interviews, collected some of the debris, and were headed back to home base on a B-25 when an explosion on their early morning flight killed them both. The Maury Island incident was written off for years as a hoax<sup>21</sup> but recent research suggests otherwise, bringing up the possibility that Crisman used his possession of the saucer debris as a means to a career among the spooks.<sup>22</sup>

Flying saucer crash retrieval rumours mounted in 1947 near the Riconosciuto stomping ground in Tacoma, Washington. The

*Tacoma News Tribune* reported upon a retrieval by William Guy Bannister, the FBI special agent in charge of the area at the time.<sup>23</sup> Bannister became famous much later in life when he shared office space with the Fair Play for Cuba Committee in New Orleans, possibly employing Lee Harvey Oswald as an *agent provocateur*.

Crisman, too, had been connected to Oswald via a subpoena from the investigation of JFK's death by New Orleans District Attorney Jim Garrison. Some alleged that Crisman was one of the three hobos photographed after their arrest in the railroad yard behind the infamous grassy

knoll on 22nd November 1963. Crisman was notably silent about both Maury Island and JFK in his 1970 memoir of life in Tacoma, entitled *Murder of a City*, written under the pseudonym of Jon Gold.<sup>24</sup> He did have warm comments about Marshall Riconosciuto, however, and recounted that the young Michael "had discovered several electronic bugs" at his father's office...

To be continued in the next issue of NEXUS...

**Just prior to leaving for Martinsburg, Casolaro had warned his brother, "If anything happens to me, don't believe it's an accident."**

## Endotes

<sup>1</sup> Ridgeway, James and Doug Vaughan, "The Last Days of Danny Casolaro", *Village Voice*, 15 October 1991.

<sup>2</sup> "Area Writer Investigating..." *Washington Post*, 13 August 1991.

<sup>3</sup> *The Inslaw Affair*, Investigative Report by the Committee on the Judiciary, 102nd Congress, 2nd Session, House Report 102-857, US Government Printing Office, Washington, DC, 10 September 1992.

<sup>4</sup> Richardson, Elliot L., "A High-Tech Watergate", *The New York Times*, 21 October 1991.

<sup>5</sup> Bleifuss, Joel, "Inslaw Breakers", *In These Times*, 9 August 1993.

<sup>6</sup> Corn, David, "The Dark World of Danny Casolaro", *The Nation*, 28 October 1991, pp. 511-516.

<sup>7</sup> Brown, Colin, "CIA Computer Genius Alleges Massive Conspiracy", *Technical Consultant*, December-January 1991, p. 7.

<sup>8</sup> "The Com-12 Briefing", *Phoenix Liberator*, 23 March 1993, p. 16.

<sup>9</sup> Cockburn, Alexander, "Meters and Mortars", *New Statesman*, 27 March 1992.

<sup>10</sup> "The Com-12 Briefing", p. 23.

<sup>11</sup> Blum, Howard, *Out There*, Simon and Schuster, New York, 1990. Sources for the history of MJ-12 abound in the rumour mill. This book, written by a two-time Pulitzer Prize nominee and former *New York Times* investigative reporter, discusses without dismissing the prospect of secret US Government

investigations of extraterrestrials. It also reproduces the infamous MJ-12 documents, from which lore about this unholy alliance has arisen.

<sup>12</sup> "A Lineman For Lincoln County: Area 51's Glenn Campbell Interviewed", *Steamshovel Press*, no. 12, 1995.

<sup>13</sup> Sauder, Richard, *Underground Bases and Tunnels*, Dracon Press, USA, 1995. Although this book does not mention Pine Gap, it documents similar underground bases around the world and provides a credible view of the tunnelling technology employed in their creation.

<sup>14</sup> Kwitny, Jonathan, *The Crimes of Patriots*, Touchstone, New York, 1987. Casolaro took extensive notes from this book primarily for its main subject, the Nugan Hand Bank scandal, which began to figure prominently in the Octopus theory.

<sup>15</sup> "The Mysterious US Base of Pine Gap", *Notes from the Hangar*, 3rd Quarter, 1991.

<sup>16</sup> Correspondence with investigator G. J. Krupcy, 8 September 1993.

<sup>17</sup> Brown, Colin, "CIA Computer Genius...", *ibid*.

<sup>18</sup> Ecker, Don, "Inslaw: Was Wackenhut A Player?" *UFO Magazine*, vol. 8, no. 1, 1993.

<sup>19</sup> Hansson, Lars, *UFOs, Aliens and 'Ex'-Intelligence Agents: Who's Fooling Whom? The Inside Story of John Lear, Bill Cooper and the Greatest Cover-Up in History*, Paragon Research, Orlando, Florida, 1991.

<sup>20</sup> According to researcher Virginia McCullough, Marshall Riconosciuto also had associations with Nixon crony Pat Moriarty, and references to both appear in Casolaro's notes. McCullough notes that

Moriarty helped arrange Nixon's first trip to China and was later connected to another conspiracy potentate, Bo Gritz. Michael Riconosciuto mentions his father in point 14 of a March 1991 affidavit for the House Judiciary Committee.

<sup>21</sup>(a) Ruppelt, Edward J., *The Report on Unidentified Flying Objects*, Doubleday, Garden City, NY, 1956, pp. 26-27;

(b) Menzel, Donald H. and Lyle G. Boyd, *The World of Flying Saucers*, Doubleday, Garden City, NY, 1963, pp. 21-23.

<sup>22</sup>(a) Flammonde, Paris, *The Age of Flying Saucers*, Hawthorne Books, New York, 1971, pp. 13-17;

(b) Halbritter, Ron, "The Hoax On You", *Steamshovel Press*, no. 12, 1995, p. 23.

<sup>23</sup> Halbritter, *op. cit.*, p. 24.

<sup>24</sup> Gold, Jon, *Murder of a City*, Tacoma, WA, USA, 1970, p. 78.

The book, *The Octopus: Secret Government and the Death of Danny Casolaro*, by Kenn Thomas and Jim Keith, is available from Feral House, POB 3466, Portland, Oregon 97208, USA.

Kenn Thomas publishes *Steamshovel Press*, an excellent journal that regularly examines conspiracy theories. Single issues: US\$5.50 in USA; US\$6.50 foreign. Subscriptions: US\$22.00 in USA; US\$26.00 foreign. Send to *Steamshovel Press*, PO Box 23715, St-Louis, Missouri 63121, USA. On the web, *Steamshovel* can be found at: <http://www.umsl.edu/~sklthoma>





# The Dobkin Technique

*This simple procedure utilises an automatic reflex which can avert brain damage and help save the lives of heart-attack and suffocation victims.*

by Jeffrey W. Dobkin

© 1986, 1993

The Danielle Adams Publishing Co.  
PO Box 100  
Merion Station, PA 19066, USA  
Telephone: +1 (610) 642 1000  
Fax: +1 (610) 642 6832

**W**hile current medical methods cannot entirely prevent heart attacks, there is an emergency procedure that can save lives. This simple technique can reduce or avert the possibility of brain damage and brain death for up to an hour or more. If this procedure saves one life, it is fully worth all the time and effort I have spent in research.

The Dobkin Technique seeks to prevent the irreversible brain damage thought to occur, in the event of traumatic accident, when no oxygen reaches the brain after four minutes.<sup>1</sup> It is a time-buying procedure for saving the lives of heart-attack victims and victims of suffocation, drowning, respiratory failure and drug overdose. Perhaps it will help even SIDS (cot death) and stroke victims until the arrival of proper medical equipment and personnel. The Technique can be applied by a child or may be self-administered in almost any home. It takes less than 30 seconds to initiate and the results are as immediate.<sup>2</sup> It works on both conscious and unconscious victims. The procedure can be easily explained over the phone.

The *Canadian Medical Association Journal* documented a case of cold-water drowning, where a boy, after half an hour of complete submersion, was resuscitated and, with proper medical treatment, experienced no lasting side-effects. He had no cerebral damage, despite his brain having received no oxygen for over half an hour.<sup>3</sup>

Research has provided additional case studies of extended cold-water submersion with no brain damage to resuscitated victims: article after article, story after story, of people deprived of oxygen for up to an hour—with no ill-effects or brain damage. What is it that protects the brain from damage in cases of oxygen deprivation over the four-minute limit? Can this be applied as a life-saving technique to heart-attack victims?

In all vertebrates there is an automatic reflex called the "mammalian diving reflex". It occurs naturally as a life-preserving mechanism during cold-water submersion. More commonly called the "diving reflex", it is a protective, oxygen-conserving reflex to keep brain and body alive in the event of submergence in cold water. The body prepares itself to sustain life. It is a totally natural, protective mechanism.

Natural engagement of the diving reflex is what has enabled drowning victims to be revived successfully after as long as an hour of cold-water submersion, with little to no ill-effects. The Dobkin Technique seeks to trigger this reflex in a crisis. The Technique may never replace cardiopulmonary resuscitation (CPR), but its purpose is not to compete with CPR but to help the thousands of victims of heart attack or suffocation who are in life-or-death situations but nowhere near any people trained in CPR.

If you are not skilful in CPR and you live in the country where an ambulance is twenty minutes away, if someone close to you has a heart attack, the options are frightening. Without initiating the Dobkin Technique, a person whose heart stops has only four minutes until irreversible brain damage starts to set in. The Technique may work in conjunction with CPR to save lives, but there is also the possibility that it may not work at all. But the fact that it just may work makes it worth closer study. In the light of no other available remedy, it could be put into practice in an emergency. What would you choose if you lived in the country and had a heart attack?

The Dobkin Technique is simple and easy to initiate. In natural surroundings, the diving reflex is triggered if you fall into water with a temperature of 58 degrees Fahrenheit (approx. 14 degrees Celsius)—the mean temperature of the world's waters—or colder. But this reflex may also be triggered by just a facial immersion in cold water, at 58°F (14°C) or colder). The Technique involves application of cold water, wet towels or wet ice-packs to the victim's head to trigger the diving reflex in the event of heart or respiratory failure. This procedure starts the oxygen-conserving mammalian diving reflex. Here is what happens:

Bradycardia can start within as quickly as four seconds, or can take up to 30 seconds depending on what part of the breath cycle the person is in when cold water is applied to the face. In man, cold-water facial immersion usually induces a 15-30 per cent decrease in



heart rate from normal resting values. The reflex is strong enough to override other seemingly vital reflexes. It can completely obliterate the tachycardia that accompanies moderately severe exercise on an exercise bicycle, and abruptly reduce the heart rate from 130-140 beats per minute to 80 or less, despite continuation of the exercise.<sup>4</sup> Bradycardia is initiated by parasympathetic vagal activity.

Skin and muscle blood-flow decrease through a powerful constriction of peripheral arteries. Peripheral vaso-constriction brought about by sympathetic activity maintains blood pressure. At the same time, systemic arterial pressure, especially diastolic, is increased. This lower heart rate and redistribution of central blood flow is to support the more necessary life-preserving organs.

The reflex triggers anaerobic metabolism, shown by a fall in arterial pH. There is an increase in concentration of lactic and other organic acids and a rise in carbon dioxide and potassium levels in the blood. This indicates that the body cells are using less oxygen.

In a study by Wolf, Schneider and Groover,<sup>5</sup> arterial oxygen saturation was found to fall very little during immersion when the reflex was triggered. Because arterial oxygen saturation falls very little, the term "oxygen-conserving" is appropriate for the reflex. Accentuation of the reflex to the greatest degree occurs when the facial immersion in cold water is accompanied by fear. The more fearful the condition, the stronger the trigger to bring about the reflex and the greater the chance that a strong oxygen-conserving reflex will take place.

In patients resuscitated by the team of a special ambulance service run by the Department of Anaesthesia at Ullevål Hospital, Sweden (from an article entitled "Resuscitation of Drowning Victims"), the most successful outcome was observed in those with cardiac arrest following drowning.

A specialist in drowning, Dr Martin J. Nemiroff (Michigan University Medical Center), suggested in an article in *Newsweek* that the involuntary diving reflex saves lives of drowning victims by delaying suffocation—by shunting oxygen from the extremities and sending it toward the heart, brain and lungs—and thus reducing the possibility of brain damage and death.<sup>6</sup> A photo in the *Newsweek* article showed Dr Nemiroff with Brian Cunningham who had been revived after 38 minutes under water. Dr Nemiroff has successfully revived numerous victims of cold-water drowning who were pronounced dead, having being submerged for 30 minutes or more.<sup>7</sup> What saved the victims was the automatic activation of the mammalian diving reflex and the coldness of the water.

In a *Scientific American* study, in a discussion of the human body's ability to resist drowning, it is stated that the diving reflex and cold water reduce the oxygen demand of tissues, extending the period of survival *without external oxygen* to as long as one hour. Previously, irreversible brain damage was thought to occur after four minutes without oxygen.<sup>8</sup>

The diving reflex is currently used by the medical profession in conversion of paroxysmal atrial tachycardia.<sup>9,10,11</sup>

It is my conclusion that if the diving reflex can save the lives of drowning victims by averting brain damage, then the Dobkin Technique, by triggering this reflex, should avert brain damage in heart-attack victims.

The Dobkin Technique involves applying cold water, ice-packs or cold, wet towels to the patient's face and eyes, in a tub or basin of cold water, being careful to leave the nose and mouth clear for breathing. The temperature of the water must be at least 58°F (approx. 14°C) or colder. Since the Technique produces an almost instant con-

version to normal sinus rhythm and is not invasive, the use of the diving reflex is recommended by many authors and cited as a safe, effective treatment. In one study, nine out of 10 patients converted in 15 to 38 seconds, with an average of 23 seconds.<sup>12</sup> Its use is also the treatment of choice for converting a supraventricular tachycardia in children and infants, in whom the diving reflex effect is most pronounced.

In 1992, I received a reply back from Dr Linus Pauling (since deceased), in which he surmised there are two ways in which damage to the brain might be prevented for some time, should the oxygen supply to the blood be stopped:<sup>13</sup>

"The brain can tolerate a certain amount of decrease in the partial pressure of oxygen supplied by the blood. If the circulation of the blood to the brain and to the tissues continues at its normal rate, the oxygen is used up rather fast, most of it (75%) by tissues other than the brain. Accordingly, the induction of bradycardia, delaying the rate at which oxygen is brought to the tissues by the blood, would conserve the supply of oxygen and permit anoxic damage to be delayed by a considerable amount.

"There is a second way of delaying brain damage by anoxia. This way is to cool the brain. The biochemical reactions involved in anoxic damage have a high temperature coefficient, so that cooling the brain by a few degrees can slow down the rate at which anoxic damage occurs to perhaps one-tenth of its rate."

Dr Pauling suggested in his letter that ice or cold water also be applied to the neck, so that the blood can be cooled and the brain itself can be cooled in the region where anoxic damage occurs. I concur with Dr Pauling and recommend that, after the patient's face is immersed in cold water or ice-packs, cold water be applied to the neck and the base of the hairline at the back of the head.

After countless hours of research, I am convinced that the Dobkin Technique will save lives. It should be a known, life-saving procedure which can be used in the event of any oxygen deprivation to the brain. It is a fast, easy-to-apply, non-invasive technique that can be explained over the telephone, be self-administered, or be applied by a friend or child with no training. And while it will not stop heart attacks from happening, it will buy precious moments—when time is of the essence—until proper medical equipment and personnel can arrive.

This natural, life-conserving, automatic reflex—which is Nature's own way of protecting us—is common enough to be found in all mammals, and powerful enough to save someone's life in a traumatic moment. Further investigation and clinical evaluation may be necessary but, from the empirical evidence I have uncovered, I recommend this reflex be initiated in time of emergent need.

I hope this article will act as a catalyst to spur new research, and I welcome readers' comments. My only request is that I'd like my name assigned to the technique (after all, Heimlich has his manoeuvre). My goal? I hope at least one life can be saved. ∞

#### Endnotes

<sup>1</sup> *Scientific American*, August 1977, p. 57.

<sup>2</sup> Wolf, S., R. A. Schneider, M. E. Groover, "Further Studies on the Circulatory and Metabolic Alterations of the Oxygen-Conserving (Diving) Reflex in Man", The Neurocardiology Research Program, Department of Medicine, University of Oklahoma Medical Center, presented before the American Clinical and Climatological Association, Colorado Springs, Colorado, USA, 21 October 1964.

<sup>3</sup> Hunt, P. K., "Effect and Treatment of the Diving Reflex", *Canadian Medical Association Journal*, no. 111, 21 December 1974.

<sup>4</sup> Atkins, J., S. Leshin, C. Skelton, K. Widenthal, "The Diving Reflex Used to Treat Paroxysmal Atrial Tachycardia", *The Lancet*, 4 January 1975, p. 12.

<sup>5</sup> Wolf, et al., *ibid.*

<sup>6</sup> *Newsweek*, 22 August 1977, p. 79.

<sup>7</sup> *The New York Times*, 7 August 1977, p. 20.

<sup>8</sup> *Scientific American*, *ibid.*

<sup>9</sup> *Newsweek*, 13 January 1975, p. 50.

<sup>10</sup> Landsberg, P. G., "Bradycardia During Human Diving", *South African Medical Journal*, 5 April 1975, pp. 626-630.

<sup>11</sup> Wayne, M. A., "Conversion of Paroxysmal Atrial Tachycardia by Facial Immersion in Ice Water", *Journal of the American College of Emergency Physicians*, 6 May 1976.

<sup>12</sup> Whitman, V., "The Diving Reflex in Termination of Supraventricular Tachycardia in Childhood" (Letter to the Editor), *Journal of the American College of Emergency Physicians*, December 1976.

<sup>13</sup> Letter from Dr Linus Pauling to the author, 2 September 1992.



# — EGYPT'S MYSTERIES —

## *Hints of a Hidden Agenda?*

*Speculation  
about secret  
tunnels and  
chambers  
underneath the  
Great Sphinx  
and Pyramid is  
reaching a  
climax as  
researchers  
clamour to  
continue their  
explorations.*

by Graham Hancock © 1996

c/- William Heinemann Ltd  
Michelin House  
81 Fulham Road  
London SW3 6RB, UK

### THE 'DOOR' IN THE GREAT PYRAMID

In March 1993, a small 'door' made of marble or limestone, with two copper handles fixed on it, was discovered by a mechanised robot, "Upuaut II" ("the opener of the way", in ancient Egyptian) at the end of a long, narrow shaft (8 inches by 8 inches, and 200 feet long).

Since then, the discoverer, robotics engineer Rudolf Gantenbrink from Munich, has been banned from resuming the exploration and opening the door. The official reason given by the Egyptian Antiquities Organization—known as the Supreme Council of Antiquities (SCA)—was that Gantenbrink leaked the news of the discovery to the British press in April 1993 and thus, apparently, broke a 'rule' of archaeology.

The Director of the German Archaeological Institute in Cairo, Dr Rainer Stadelmann, sided with the Egyptians and condemned Gantenbrink for his press action. Dr Stadelmann was adamant about the non-importance of the find: "This is not a door; there is nothing behind it."

The President of the Supreme Council for Antiquities, Dr Muhamad Bakr, went as far as claiming a "hoax": "The orifice of the shaft is too small for the robot to go through," he said, and accused the "German scientist" of not having the correct "approvals" from the SCA to carry out the exploration. Dr Bakr fired the Director-General of the Giza Pyramids, Dr Zahi Hawass, although the official reason given was that a valuable ancient "statue" under the custody of Hawass had been stolen from Giza.

Three months later, in June 1993, Dr Bakr himself was fired and replaced by Dr Nur El Din. Amid accusations of malpractice and fraud, Dr Bakr spoke of a "mafia" which had been involved with the pyramids for "the last twenty years". Refusing to give names, Dr Bakr said, "I wanted the whole matter investigated by the prosecution authorities, but my request was refused."

Meanwhile, Dr Hawass, who went to the USA, claimed that the discovery of the 'door' was "the discovery in Egypt", and speculated on important artefacts behind it. In early 1994, Dr Hawass was reinstated at his post at the Giza pyramids.

Meanwhile, Gantenbrink offered his robot to the Egyptians and also offered to train an Egyptian technician to man the equipment and open the door. The Egyptians rejected the offer: "We are very busy at the moment," replied Dr Nur El Din.

About the same time, Dr Hawass was to declare: "I do not think this is a 'door', and there is nothing behind it." In March 1996, however, Dr Hawass changed his mind once again and declared Gantenbrink's find as being one of huge interest and that the 'door' would be opened in September 1996 by a Canadian "mission", but not including Rudolf Gantenbrink or his robot. The Canadian "mission" is owned by Amtex Corporation of Canada, a multimedia CD-ROM company, reported to be raising the huge sum of US\$10 million to promote a staged 'live opening' of the door on television networks.

"I'm working with a private guy who is a personal friend of Hawass, and we are absolutely going to drum this thing to death. Whatever the event we are going to stage, it will be televised live," reported Amtex Corporation's president, Peter Zuuring.

### TUNNELS AND CHAMBERS UNDER THE GREAT SPHINX

In a series of expeditions between 1991 and 1993, led by independent Egyptologist John Anthony West, scientific investigators conducted geological and seismic surveys around the Great Sphinx of Egypt. The chief geologist was Dr Robert Schoch, Professor of Geology at Boston University, and the chief seismologist was Dr Thomas Dobecki, from the highly respected Houston consulting firm, McBride-Ratcliff & Associates.

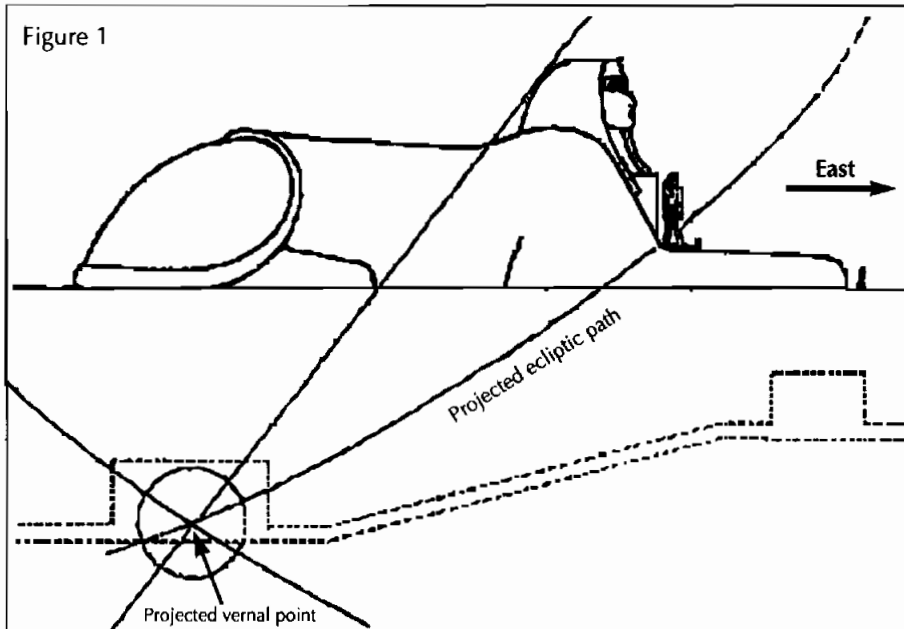

Figure 1

Sphinx. He appeared to be angered by the suggestion that the Sphinx might be far older than the civilisation of Egypt itself—and thus the work of a lost civilisation—and was particularly incensed by an NBC television film that was made about the team's work. This film linked the Sphinx to Atlantis, and suggested that the chamber beneath the paws might contain the legendary Hall of Records of Atlantis.

Hawass called these claims "American hallucinations" and said, "There is no scientific base for any of this. We have older monuments in the same area. They definitely weren't built by men from Atlantis. It's nonsense and we won't allow our monuments to be exploited for personal enrichment. The Sphinx is the soul of Egypt."

An article in the Egyptian press, responding to the NBC film, quoted Dr Hawass on his further reasons for expelling John West and his team from the Sphinx enclosure: "I

The team's conclusions were as follows:

**1) Geology:** The pattern of erosion on the Sphinx indicates that it was carved at the end of the last ice age, when heavy rains fell on the eastern Sahara—perhaps more than 12,000 years ago. This contrasts starkly with the 'orthodox' Egyptological dating for the Sphinx of around 4,500 years ago.

**2) Seismography:** The seismic survey indicates the existence of several unexplored tunnels and cavities in the bedrock beneath the Sphinx, including a large rectangular chamber at a depth of some 25 feet beneath the monument's front paws.

In 1993, John West and his team were physically expelled from the site by Dr Zahi Hawass, then (and now) the Egyptian Government's Chief Inspector of Antiquities for the Pyramids and

have found that their work is carried out by installing endoscopes in the Sphinx body and shooting film for all phases of the work in a propagandistic but not scientific manner. I therefore suspended the work of this unscientific mission and made a report which was presented to the Permanent Commission who rejected the mission's work in the future."

The NBC film was produced by a certain Boris Said and partially financed by investments from the members of the Association for Research and Enlightenment (ARE). The ARE, headquartered in Virginia Beach in the USA, is a multimillion-dollar organisation that exists to promulgate the teachings and prophecies of the American psychic, Edgar Cayce, who died in 1947.

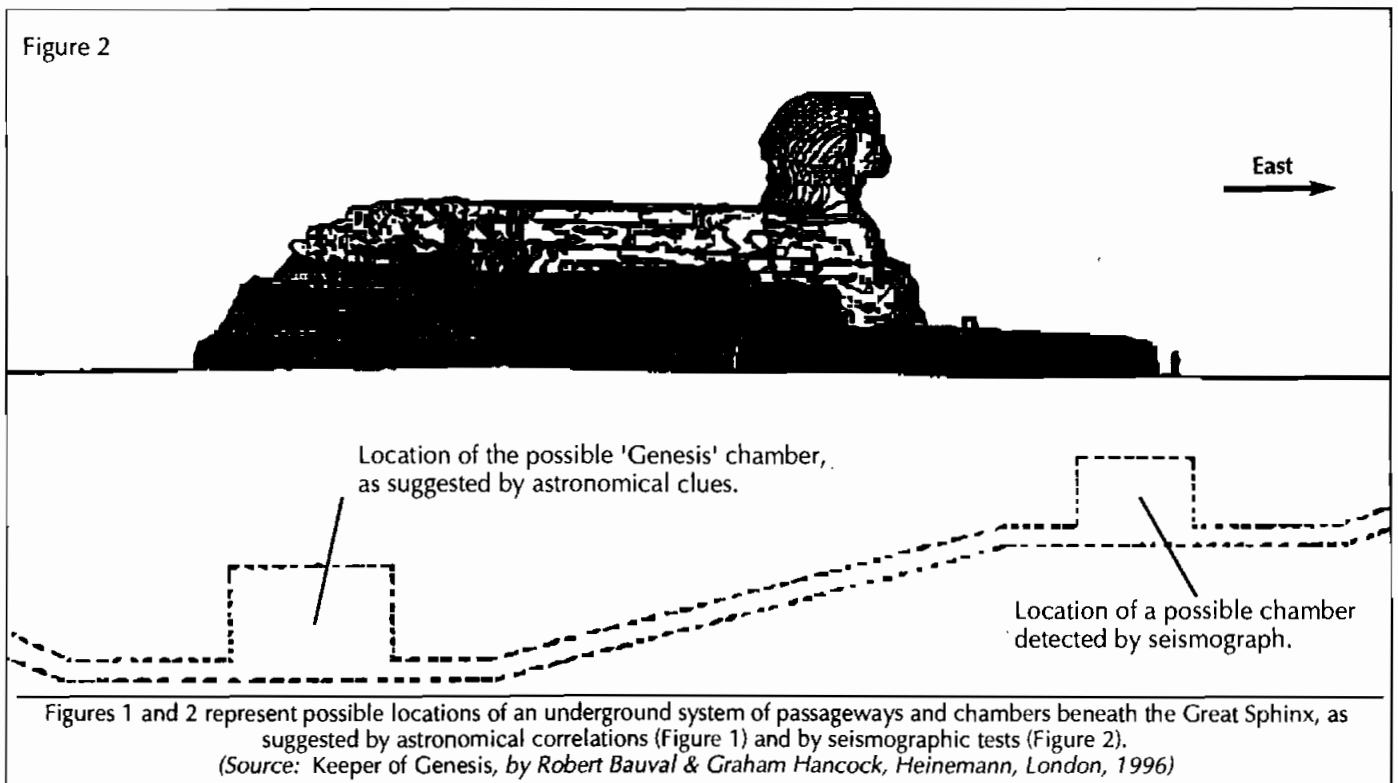

Figure 2

Figures 1 and 2 represent possible locations of an underground system of passageways and chambers beneath the Great Sphinx, as suggested by astronomical correlations (Figure 1) and by seismographic tests (Figure 2).

(Source: *Keeper of Genesis*, by Robert Bauval & Graham Hancock, Heinemann, London, 1996)



Author and researcher, Graham Hancock.

Prominent amongst Cayce's pronouncements were many statements to the effect that the Sphinx had been built in 10,500 BC, and that survivors of Atlantis had concealed beneath it a Hall of Records containing all the wisdom of their lost civilisation and the true history of the human race. Cayce prophesied that this Hall of Records would be rediscovered and opened between 1996 and 1998. He connected the opening to the second coming of Christ.

In 1995, John West and Prof. Dr Robert Schoch of Boston University put in an application to the Egyptian authorities to resume their research. Their application was ignored.

At the beginning of April 1996, the Egyptian authorities granted a one-year licence to a new team to conduct surveys around the Sphinx and the Giza necropolis using seismic equipment and ground-penetrating radar. This team, which claims academic sponsorship from Florida State University, is largely financed through the Schor Foundation of New York, by Dr Joseph Schor, an American multimillionaire.

Dr Schor is a life member of the ARE. On 24th May 1994, he wrote of his great personal interest in corroborating "the Cayce records, which indicated that the culture which led to the building of the pyramids dates to 10,500 BC. He also stated his wish "to further delineate that civilisation".

On 11th April 1996, Dr Schor said of his current project at the Sphinx: "We do not work for the Edgar Cayce Group... The major purpose of the Schor Foundation and the Florida State University is to aid in the preservation and restoration of the pyramids and Sphinx. In addition, we are surveying the underground of the Giza Plateau to find faults and chasms that might collapse. This will increase the safety of the plateau..."

**The pattern of erosion on the Sphinx indicates that it was carved at the end of the last ice age, when heavy rains fell on the eastern Sahara—perhaps more than 12,000 years ago.**

Also financed by Dr Schor is a short video, shot at the end of 1995 by Boris Said and produced in early 1996. The film opens with Dr Zahi Hawass scrambling into a tunnel leading under the Sphinx. When he reaches the bottom he turns to face the camera and whispers to the viewer: "Even Indiana Jones will never dream to be here. Can you believe it? We are now inside the Sphinx in this tunnel. This tunnel has never been opened before. No one really knows what's inside this tunnel. But we are going to open it for the first time."

In commentary, the video's narrator goes on to state: "Edgar Cayce, America's famous 'Sleeping Prophet', predicted that a chamber would be discovered beneath the Sphinx—a chamber containing the recorded history of human civilisation. For the first time we'll show you what lies beneath this great statue...a chamber which will be opened tonight, live for our television cameras."

Dr Schor also stated on 11th April that this video is not a promotional venture aimed at hooking a major US network to televise a live opening of a chamber under the Sphinx. On the contrary, he insists, "It was made to test script and equipment and was made in November 1995...many months before we received approval for our expedition. We have abandoned its use..."

On 14th April 1996, Dr Zahi Hawass announced in the Egyptian press that secret tunnels do indeed exist under the Sphinx and around the pyramids, and stated his belief that these tunnels would prove to "carry many secrets of the building of the pyramids".

∞

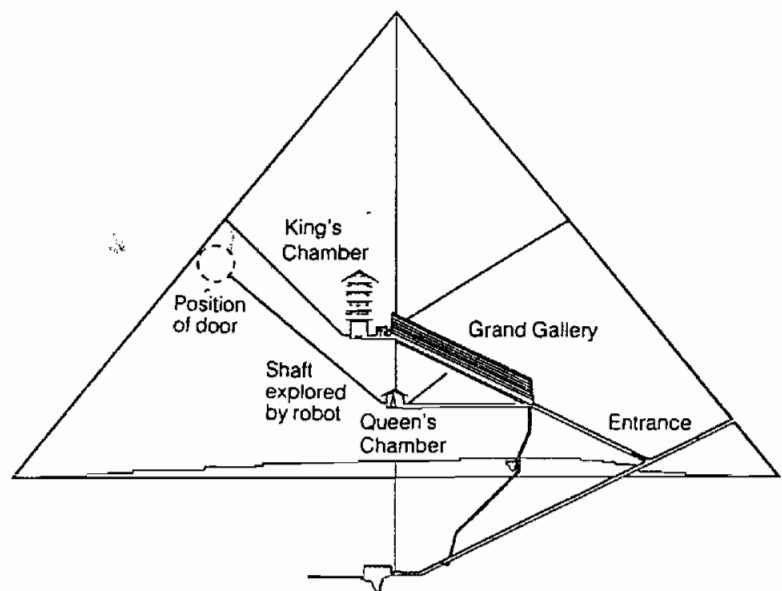

Figure 3: Cross-section through the Great Pyramid at Giza showing chambers, passageways and shafts, including the one explored by the robot, Upuaut II. (Source: *The Orion Mystery*, by Robert Bauval & Adrian Gilbert, Heinemann, 1994)

# The Key to Humanity's Mysterious Origins

*Are the ancient  
Egyptian  
secrets of  
creation and  
regeneration  
coded into the  
sacred  
landscape  
geometry of  
Rennes-le-  
Château?*

*Part 3*

**by David Wood and  
Ian Campbell © 1984-1995**

Genisis Trading Co. Ltd  
Wellwood, North Farm Road  
High Brooms, Tunbridge Wells  
Kent TN2 3DR, England, UK  
Phone +44 (0)1892 544044  
Fax +44 (0)1892 511301

## THE EGYPTIAN CONNECTION

**D**espite the idea that the Egyptian culture was supposed to have laboured for thousands of years, transforming from the primitive to the pyramid builders, the truth is that there is no local evidence whatsoever to support this. Quite to the contrary, the civilisation appears to have arrived there intact, and in an advanced state of development, from a place as yet unknown. With them came their legends of times even more remote. In these legends were fascinating stories of the interplay between the gods—stories in which they were given various titles, zootype imagery and apparently inexplicable numerical values.

It is reasonable that the first of the myths we will examine is the Egyptian myth of the Creation. Here, Nut, the Queen of the Heavens and Mother of the Gods, angered Ra, the Sun God, by secretly consorting with her brother, the Earth God Geb, "the Great Cackler", and "they laid horizontally together". So incensed was Ra by this incestuous act that he sent Shu, great God of the Pillars of Light and the father of Geb and Nut, to separate his children. Shu commanded them to part, which they did, and in so doing performed the first act of creation.

Nut's star-spangled body remained forever separated from her brother, arched from horizon to horizon, so dividing the Earth and the sky (see illustrations, following pages). However, a union had already taken place and Nut was pregnant. Knowing this, Ra, in anger, forbade Nut to shed her offspring on any of the days of his year. The Earth's year is believed to have been 360 days long at that time. Some consider this to be one reason why the circle is divided into 360 degrees.

Thoth, Lord of the Measures who controlled the movement of the stars, took pity on Nut and came to her assistance. He played the Moon at chequers and won from her a 72nd part of her light, whereby five (360 divided by 72 = 5) days were intercalated to the year. With these additional days available to her, Nut was now able to give birth, and this she did to the pantheon of five gods named Set, Isis, Osiris, Nephthys and the child-god Horus.

Isis was queen to Osiris, and it was he who was said to be responsible for the transformation of mankind from barbarism and cannibalism into civilisation. Osiris supposedly moved around the world introducing the people to agriculture and science. During his absence, Isis ruled over Egypt and was greatly revered. Set, brother of Osiris, desired Isis and was also jealous of the power, popularity and success of Osiris. Eventually Set devised a plot to murder him.

Set's plan was to construct a chest of exceptional beauty, shaped in such a manner as to fit precisely the body of Osiris. Then he and 72 accomplices would invite Osiris to a banquet. Each of them would lie in the chest on the understanding that the one who fitted it best would take it as his own. The plan succeeded, for when Osiris climbed into the chest they quickly sealed the lid and threw the chest into the Nile. On hearing this, Isis was grief-stricken and went in search of her husband's body. Isis had the power to resurrect the dead and eventually she recovered the body.

Set, knowing Isis' powers, realised that Osiris would live again. Determined not to be outdone, he cut his brother's body into pieces and scattered them far and wide. The loyal Isis gained great respect from her subjects when they saw the way she would not rest until she had recovered all the parts of her husband's body. Nephthys, her sister, assisted in the search, for despite being the wife of Set she did not approve of his actions and was always ready to help Isis in times of need. Eventually, all the parts of the body were recovered

except one—the phallus; so, remembering that the male body consists of 15 parts, 14 were found and one was lost. This numerically synchronises with the 14 points at Rennes-le-Château which are contained within the circle, and the one part extending outside of it.

Returning to the legend, we find Isis with the body of her husband, resurrected but lacking the essential phallus. Furthermore, we should note the persistence of the number 72 and remember that this is the base angle of a pentagonal body triangle. Here, we are probably seeing the Jesus story being enacted thousands of years before the Christian myth was conceived, and we may wonder whether this could be its origin. Even the three-day resurrection time of Jesus conforms to the pentagonal discipline where the three-day period could be seen as 72 hours. It is also highly probable that Jesus suffered the same de-phalusing that Osiris did. This subject is covered in more detail in *Genesis*.

More relevant to our enquiry is the god Set, known to the ancient Greeks as the Typhon. Among his contradictory titles we find God of the Deep, God of Time, the Ice God, Lord of the Desert Wastes, God of Volcanos, etc. His colour was red, and, for no reason as yet discovered, his number was 56. As confusing as these titles at first appear, they could easily be interpreted as the varying descriptions of the effect of a celestial impact with the planet Earth—possibly by a huge comet or asteroid. Initially would come the searing heat of the thermonuclear impact, followed by seismic upheavals, then massive tsunamis thousands of feet high, rushing round the Earth in a matter of hours. In the aftermath, billions of tons of dust would be trapped in the upper atmosphere, blocking out sunlight and causing the inevitable subsequent ice age.

Returning to the plight of Osiris, a bizarre solution was suggested whereby a wooden phallus could be created to restore the god's sexuality. Logically, however, the pantheon was now reduced to the barren Nephthys, the child Horus, the comely, fertile Isis and the lustful Set. This effectively restricted any further procreation to an Isis/Set union.

However, regardless of what we may infer from these legendary interplays, our interest is that Plutarch, in *De Iside*, clearly states that "...even the Pythagoreans looked upon the Typhon to have been of the rank or order of Demons produced according to them...the even number of 56..."

In addition to this, the Anglo-Saxon chronicler Holwerda stated that Set was only in his mother's womb for 224 days ( $4 \times 56$ ), and he also made reference to Set having torn through the side of his mother's womb.

### THE FRENCH MERIDIAN

Finally, we should bear in mind that a meridian is the origin or zero time marker of longitude, and that one of Set's titles was the God of Time. Remarkably, all these references are incorporated into the geometry of Rennes-le-Château, and we trust the reader will be as impressed as we were by its ingenuity.

Together with the obviously female extended pentagram, generated from the circle of ground features and enclosed in a 43-square-mile rectangular 'Temple', the Paris Meridian is to be found (see Figure 6). This is the French zero time line of longi-

tude which lost the international battle for acceptance to the Greenwich Meridian. Its dominant position, together with its coincidental intersections with the geometry, demanded careful evaluation.

Already it had two intersections resulting from the analysis of another of the profound geometric figures which we discovered during our investigation. These positions showed two equal divisions on the meridian from where it enters the Temple on its northern boundary. We then found that a further four divisions of exactly the same dimension terminated precisely at the point where the Paris Meridian intersects the southern wall of the Temple.

Obviously, the measure was critical to the solution and we were already trained to consider linear distances in terms of the sines of angles. The distance was some 82,904 AU (Ancient Units) which, by applying the 100,000 multiple reduction, revealed it to be the sine value of 56 degrees! Thus informed, we measured the chord created by the meridian passing through the circle. It was 331,615 AU, which we quickly recognised as four times sine 56 degrees! Finally we found that the perpendicular distance from the chord to the centre of the circle is, once again, 82,904 AU—the sine of 56 degrees!

Even the most sober mind would have to reel at this level of precision, but its doctrinal implications are no less staggering. Here was the perfect geometric representation of Set breaking from the womb in four days, as was so clearly described by Holwerda.

We recalled that the tomb depicted in Nicolas Poussin's painting, *Les Bergers d'Arcadie*, had been replicated close to the meridian on the road from Arques to Couiza, and we had noted that it displayed 56 facing-stones. Again, the confirmations rushed in and left us in no doubt that Poussin was fully cognisant of the Set connections—and as to why we had found other such evidence in his work.

As we have previously stated, the antiquity of the circle markers was clearly established, but how could the Paris Meridian be considered to be contemporaneous with them? Initially, one could be misled into assuming that it dated to

the construction of the Paris Observatory through which it passes. This would certainly be true in the case of the Greenwich Meridian, but further enquiries revealed that this was not so for the Paris Meridian. In fact, the Paris Observatory was constructed in order to coincide with a previously established meridian of great antiquity—so ancient that the reason for its location is lost in the mists of time. In the light of our discoveries, however, we felt justified in considering that the reason for its position was inexorably linked to the landscape geometry.

In *Geneset* we presented further confirmation of the Egyptian connection where the mathematical analysis of the Great Pyramid, by the Greek grammarian Agatharchides, displays self-evident correspondences with the geometry of Rennes-le-Château. Other historical evidence beyond the scope of this article can also be found in the book.

Furthermore, a massive Pythagorean triangle projected from the church of Rennes-le-Château, with the meridian as the hypotenuse, discloses a precise figure for the plane of the Earth's ecliptic. However, as obvious as this and many other connections



The Egyptian Goddess, Nut.

are which can be made with the geometry, one must exercise caution in their interpretation. As we have always said, the geometry of Rennes-le-Château is provable and undeniable, whereas its interpretation might always be arguable.

Initially, we were severely criticised for identifying Set as a celestial body capable of devastating the Earth. Nevertheless, in the intervening years between the publication of *Genesis* and *Geneset*, a number of astronomers have reached the same conclusion. Careful examination and comparison of the legends which speak of destruction from the skies, as well as the geological and palaeontological evidence, have confirmed our worst fears: that planet Earth is far from being the safe haven which the past few hundred uneventful years have led us to believe.

The current description of the comet being a "dirty snowball" is considerably more comforting than the legendary descriptions of a "malevolent Ice God" or "fiery red serpent"—descriptions which are certainly far more accurate. We should not overlook that, in more recent times, H. S. Bellamy saw the Book of Revelations in the Bible as an account of catastrophic damage to the Earth by a celestial agency, and I. Donnelly's *Ragnarok, The Age of Fire and Gravel* was dismissed as fanciful, if not heretical.

This leads us to another well-informed gentleman who, for fear of ridicule or even persecution, decided to record his opinions in coded form.

### JULES VERNE AND NICOLAS POUSSIN

It was the relationship between the "Arcadia" inscription and Set which finally convinced us of the identity of another custodian of the secret who lived in comparatively recent times: the famous French author, Jules Verne. One of his *Voyage Extraordinaire* stories was "La Chasse au Météore" ("The Search for the Meteor"). The story is saturated with cryptograms and innuendo which leave us in no doubt that Verne was closely associated with the enigma of Rennes-le-Château. Others had suspected this was so, but we had the advantage of knowing the manner in which Set had been woven into the Arcadia coding of Poussin's painting and, furthermore, of his legendary identification with global catastrophe. In view of this, we were able to understand the strange marriage and divorce which occurred between two of the characters in the story: Seth Stanford and Arcadia Walker.

Bearing in mind that by Verne's time Christianity had decided to equate Set with Satan, the reader will probably immediately be partially aware of the message which Jules Verne was attempting to convey. A full explanation of this intriguing code, and a great deal more, is to be found in *Geneset*.



The arched body of Nut, the Sky Goddess, separated from Geb, the Earth God or "Great Cackler".  
(From the Papyrus of Tameniu, British Museum)

As we discovered each new part of the jigsaw, it was becoming increasingly obvious that a picture was forming which would be totally unpalatable to any number of 'authorities', and on many occasions we doubted the wisdom of publishing our findings. Having already alienated the chauvinistic Christian diehards in *Genesis*, we were now about to disclose that, far from being the 'holy place' that some would have wished it to be, Rennes-le-Château was actually an institution of advanced intellect. Furthermore, with the structure of the mystery unquestionably proven to be one of mathematical discipline, we were effectively creating redundancy for those who had banked upon it remaining mysterious enough to provide them with income for years to come.

Being blissfully unaware that mathematics was anti-Christian, we persisted with the geometric analysis, only to be labelled by some as being "in league with the Devil", or "Satanists". Intrigued by these accusations, we referred to that reliable tome, the *Encyclopaedia Britannica*, only to find that "Satan" was neither catalogued nor cross-referenced. Under "Devil", however, we were more fortunate and found copious notes equating these two personae, together with various theological arguments as to their identities. However, the entry concludes with the profound statements:

*"Interesting as these speculations are, it may be confidently confirmed that belief in Satan is not now generally regarded as an essential article of the Christian faith, nor is it found to be an indispensable element of Christian experience. On the one hand, science has so explained many of the processes of outer nature and of the inner life of man as to leave no room for Satanic agency."*

(*Encyclopaedia Britannica*, vol. 7, 1961)

We may also do well to remember that many of our most eminent theoretical physicists do not consider there is any room for the Christian God in their scenarios.

Returning to the geometric ground figure, and armed with the trigonometric and doctrinal weaponry we had gathered, we found that veil after veil was being lifted to reveal the mathematical magnificence of its construction. Even in isolation, any one of the component figures was enough to convince the most hardened sceptic of the ingenuity of the designers, but for the figures to be integrated with the harmony and accuracy that the computer was displaying was nothing short of awesome! This was indeed the work of the gods, and we had no alternative other than to publish what we had found, regardless of our rapidly diminishing potential readership.

The workload of preparing the findings for publication effectively halted further research, but when *Geneset* went to press we were once more free to pursue the refinements of the mathematics. It was at this stage that we found a minor miscalculation in the frame size of Poussin's painting, *Les Bergers d'Arcadie*.

As insignificant as it was, it had nevertheless obscured the mathematical brilliance inherent in its construction. The height and width were originally thought to be 34.285 inches and 47.19 inches respectively, but we eventually found that they should have been 34.23803459 and 47.1246118. Although the variation was immeasurable by normal means, with that minor difference we had



overlooked the ultimate secret of Poussin's painting. By substituting the new mathematically deduced dimensions and the evaluations resulting from them, the geometric analysis of the painting proved that Poussin was not only fully conversant with both the shape of the ground geometry and its doctrinal connection but he had also scaled his painting to it. The full proof of his achievements is explained and analysed in *Poussin's Secret*.

### A MATHEMATICAL MIRACLE

At last it seemed possible to rest from our labours and put our house in order. The computer's hard disc was littered with intermediate drawings and failed attempts which required either enumeration or erasure. Once more, fate took a hand and something of our early work came to light which screamed for examination. This new discovery is as yet unpublished, but we felt that if its significance were to be realised anywhere, it would be among the readers of NEXUS. Again, we will prepare the reader with a few reminders.

We know that the angles of the Euclidean plane triangle will always have the sum of 180 degrees. Furthermore, by use of the sine formula, all the properties of any triangle can be deduced by knowing either two angles and a corresponding side, or two sides and a corresponding angle.

Additionally, those who are familiar with sacred geometry will know that if a dimension of a structure can be equated to another by the circular control factor of  $2\pi$  (two times the value of  $\pi$ ), the structure is considered 'holy'.

Lastly, as any mathematician will know, there is no mathematical precedent for calculating the product of the angles of a triangle (i.e., multiplying the three angles together).

As the reader will recall, we had established the unit of measure which the designers had used, and that it could be translated into British Standard Inches by a fractional conversion factor.

With all this in mind, we can now reveal that the product of the angles of the pentagonal body triangle in the ground geometry is 188,721.5882 AU. This figure, when multiplied by  $2\pi$  in order to 'sanctify' it, becomes 118577271 AU—still a seemingly nondescript number.

Now we must recall that enigmatic number 681 which we found in the decoded parchment and first alerted us to the sine method of reading linear values. By moving the decimal place, we find the sine value of 6.81 degrees is, unbelievably, also 118577271! We knew that whatever that figure was, it must be vital.

Even having lived for years with the miraculous mathematics of the design, we were nevertheless still shocked when we realised that by applying a conversion factor which was within 10 millionths of an inch of that deduced from the map by the computer, this number in British Standard Inches becomes 1180306556.

At first sight, this value may also appear to be of little interest, but when divided by 63360 (the number of inches in a mile) to

find its equivalent in miles, it becomes 186,285.757—the latest NASA figure for the speed of light in miles per second!

Any lingering doubts we may have had as to the intellectual stature of the designers were gone. Such a devious and unprecedented use of mathematics woven into such a complex trigonometric matrix could never be explained away as coincidental. Who would dare to malign themselves by claiming this to be 'happstance'?...unless, of course, they would consider its discovery would derail the history of Mankind and destroy the false beliefs to which they cling.

One would imagine the designers had exhausted the amount of information which they could convey in one simple triangle, but the mathematically-minded may be bemused by the final *coup de grâce*. The reader will recall that we were surprised to find the equation of the body triangle to the circle's circumference had been sacrificed when it had been enacted in the ground figure. The new value of the triangle's perimeter was numerically 1172436179, as opposed to the circle's circumference of 1164966625, and for a while we could find no reason for the new value.

After a little computer play, however, we realised that this was precisely the value of the hypotenuse of an isosceles right-angled triangle with sides of sine 56. As 56 is the previously identified signature of the malevolent destroyer, Set, we now had the geometric union of Mother Earth and the comet of destruction.

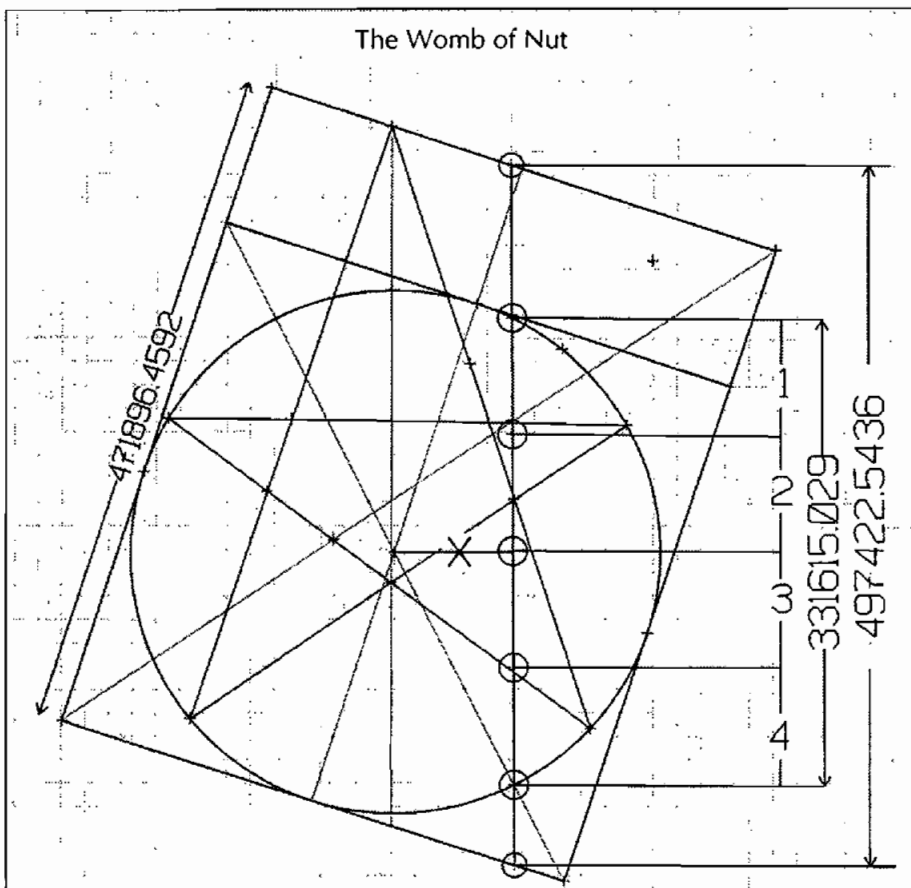

Figure 6: From the point where the Paris Meridian enters the Circle of Churches to its point of departure is precisely  $4 \times \sin 56$  degrees, and the total length of the meridian between the Temple walls is  $6 \times \sin 56$  degrees. Remarkably, the perpendicular distance, X, to the centre of the circle is  $\sin 56$  degrees, i.e., 82,903.7572. All these figures have naturally been subjected to the 100,000 multiple, for their translation into ground measure.

## A POSSIBLE EXPLANATION

There is an ever-increasing flow of technological evidence which contradicts the academic and religious brainwashing we have been subjected to since the layman had access to the printed word. At first sight it may appear to be indecipherable and contradictory within itself, but there is a scenario—unpalatable as it may be—which will accommodate it all.

It is of a planet where, despite several setbacks, life persisted and eventually produced a primitive hominid. So much we can grant the evolutionists, but, at 200,000 years ago, an outside agency genetically accelerated our species, possibly for the purpose of becoming menial servants. Nevertheless, from their genes we were gifted with their excessive brain capacity.

The secondary creation, *Homo sapiens*, also experienced countless setbacks by lesser celestial impacts, the last of which may have been some 10,000 to 15,000 years in the past. The remnants of that advanced culture were once again reduced to savagery, and our academic teaching is based upon the fact that they, in their primitive state, were our beginnings.

What is only just starting to emerge is that, throughout that period of savagery, a handful of survivors tried to preserve the knowledge of their golden past in the stories they passed down through the ages. For them, it would have been imperative to attempt to preserve sufficient of their knowledge to demonstrate the extent of their achievements to the emergent culture, if only in the hope that this would accelerate the process of recovery. Possibly they never expected that this information would be classified as folklore and legend. And they would most certainly never have expected that it would be suppressed and replaced with a form of science so dominated by religious doctrine as to deny they had ever existed.

But what if evidence of their advanced intelligence had survived the aeons? And what if its rediscovery found some who were willing to chance being 'burned at the stake' in order that it be preserved?

The fact is, the evidence *did* survive, as this article reveals. ∞

### About the Authors:

**David Wood** is qualified in the fields of trigonometrical and topographical surveying and cartographical reproduction. This unusual combination of skills, together with his study of legends, permitted him to discover an ancient geometry concealed in the valley of Rennes-le-Château. After years of refinement, his observations and calculations have been proven correct.

**Ian Campbell** is an investigative journalist, author and photographer who has been examining the geometric and historic aspects of the Rennes-le-Château mystery since 1982. He independently verified David Wood's early research before joining him in the culmination of his studies, revealing the awesome secret of Rennes-le-Château.

This article, *The Key to Humanity's Mysterious Origins*, is based on material from the books *Genesis*, *Geneset* and *Poussin's Secret*, which are distributed by Genisis Trading Co. Ltd, Wellwood, North Farm Road, High Brooms, Tunbridge Wells, Kent TN2 3DR, England, UK; phone +44 (0)1892 544044, fax +44 (0)1892 511301.





# White Powder Gold

## A Miracle of Modern Alchemy

*This elusive substance not only has superconducting properties which transcend time and space, but is capable of raising human consciousness and restoring perfect health.*

*Part 2*

**A Lecture by David Hudson**

Portland, Oregon, USA  
28 July 1995

Science of the Spirit Foundation  
PO Box 25709  
Tempe, AZ 85285, USA

One thing we did was we took our white powder and we said, "Now, if this is a superconductor, we should be able to put this white powder down on the table and should be able to hook up a voltmeter to it." Your voltmeter has got two electrodes, and you put it on a wire, turn on the battery pack and it tells you the resistance in the wire.

Well, if you touch the powder with one electrode on one end and the other electrode on the other end and turn on the electricity, you just figure the needle is going to go 'boing', just like this, right? Perfect conductivity, right? Nothing. Zilch. Nothing. No conductivity at all. So we think, "What's going on here?"

We found out that the definition of a superconductor is that it does not allow any voltage potential or any magnetic field to exist inside the sample. So, by definition, a superconductor will not allow any voltage potential to exist inside the sample. To get electricity off a wire requires a voltage, and to get electricity back on the wire requires a voltage.

So now I know your question is, "So what the heck good is this stuff? If you can't get energy into it and you can't get energy back out of it, what the heck good is it?" Well, what you come to find out is that in the superconductor there is a single frequency of light, just like a laser, that is flowing perpetually inside the superconductor. And when it flows inside the superconductor it produces around it what is called a Meissner field, which is unique to superconductors.

A Meissner field excludes all external magnetic fields from the sample. What colour must it be? It has to be white. Anything that excludes all light from the sample has to be white. Anything that absorbs all light has to be black. If it reflects all light it has to be white. Now, I'm talking about a pure single element superconductor. It has to be white when it is superconducting.

What you have to do is take a radio frequency transmitter and resonant-frequency-tune the superconductor to match the frequency of the wire. So now, the wire is in oscillation with its electron waves, exactly the same as the superconductor. At that point the electron pair can go on the superconductor with no push at all, because electrons are continually moving on the wire, seeking the path of least resistance. When you have them in perfect synchronisation with the superconductor, they go on with no push at all as pairs.

This takes a little explaining because one spin-one half electron plus one spin-one half electron are two particles. Yet when these two particles become perfectly paired as mirror images of each other, they lose all particle aspects and they become nothing but pure light. This doesn't make sense either, does it? But that's the way it is. Spin-one half plus spin-one half gives you spin one which is now pure light. Trust me, it is so. So they can't go on as individual electrons; they go on as light.

The crazy thing about electrons is that one electron can exist in one space-time, and if it moves to another space-time it gives off light or absorbs light. It's moving from one space-time to another. Now we have light, which is two electrons. Light doesn't exist in any space-time. You can put 50 billion lights all in the same space-time and it is okay.

Now we don't have a conductor. If you put electricity on the wire, you've got to take the electricity off or it won't flow. You've got to ground it, right? With a superconductor, that's not so. It can go on, and go on, and go on, and go on; it doesn't have to come off. If you want to take it off, you have to put a wire next to it and you have to resonant-frequency-tune the wire to match the superconductor. And when it's in perfect harmony you apply a voltage and, 'poof', off goes the energy.

So if you could literally make a superconductor that stretches from Portland to New

York City and you put energy on over here for two or three or four days, you don't have to take it off over there. It's okay; you can keep putting it in. When they want the energy in New York they can resonant-frequency-tune the wire, apply voltage and suck it out. It gets a free ride from Portland all the way to New York on this quantal wave of the superconductor—as light, not electricity.

How do you measure this light if it has no voltage in it? How is it possible to get a machine that can measure this light? Guess what? It can't be done, 'cause every piece of instrumentation man has ever figured out always uses a differential that it must reflect, and yet a superconductor has no voltage.

You literally start the superconductor flowing by applying a magnetic field. It responds to the magnetic field by flowing light inside of it and building a bigger Meissner field around itself. You can put your magnet down and walk away. You can come back a hundred years later and the superconductor is still flowing exactly the same as when you left. It doesn't ever slow down. It excludes not 99.99999, but 100.00000 per cent of all external magnetic fields. There is absolutely no resistance in the sample; it is perpetual motion. It runs for ever and ever and ever and ever.

The Russian physicist Sakharov said in the 1960s that we are looking for gravity but we are never going to find it as a magnetic field. Gravity is what is produced when protons, neutrons and electrons interact with the vacuum energy—that energy that is everywhere in the Universe, timeless; that energy that is there like the ether. When you pump out all heat and all matter, everything, there still is energy there—the vacuum energy. If there is no matter, there is no gravity. Interesting theory. Everyone kind of ignored it for a while.

There's this fellow by the name of Hal Puthoff, who worked over in the Bay Area in California doing distant-viewing experimentation and is now working down in Austin, Texas [at the Institute for Advanced Studies]. He actually developed the mathematics for Sakharov's theory of gravity and published it in one of the top science journals.<sup>1</sup>

In the mathematics he shows that when matter begins to interact in two dimensions, as opposed to interacting in three dimensions (by definition, a superconductor is a resonance-coupled quantum oscillator resonating in two dimensions, not three dimensions), it should theoretically lose four-ninths of its gravitational weight. Did you know that five-ninths is 56 per cent, exactly?

I decided, "I've got to go down and see Hal Puthoff. I've got to take all my data and go down and see Hal Puthoff."

So I did, and I said to him, "Hal, we have the experimental confirmation that, in fact, your mathematics are absolutely correct. In addition, Sakharov's theory of gravity is absolutely correct, because this material only weighs 56 per cent when it goes to the superconducting state.

Hal Puthoff said, "Dave, you do realise that gravity is what determines space-time? When this material only weighs 56 per cent of its true mass, you do realise that this material is actually bending space-time?"

Now if you think about this, it seems correct.

He said, "Dave, what we really need is a material that totally bends space-time; a material that has no gravitational attraction at all. Less than zero."

It's what he called "exotic matter" in his papers.

I said, "Hal, do you realise that if you heat this material it has no gravitational attraction at all?"

I'd been reading papers on the vacuum energy. Do you know that there is an overlap between the thermal spectrum and the zero-point spectrum? The two of them overlap. So if you heat something, it should interact with the zero-point energy. Well, because this material is resonating in two dimensions, when you heat it, it literally loses all gravitational attraction. You know what Hal Puthoff said to me?

He said, "Dave, at that point you shouldn't be able to see the material."

**"Hal Puthoff said,  
'Dave, you do realise  
that gravity is what  
determines space-  
time? When this  
material only weighs  
56 per cent of its  
true mass, you do  
realise that this  
material is actually  
bending  
space-time?'"**

I said, "Correct. You can look in the pan through the quartz tube and there is nothing in the pan. But the pan isn't weighing what it would weigh if the stuff wasn't in it."

Now I had mistakenly assumed that the material was just resonating at a frequency we didn't perceive.

He said, "Dave, theoretically it should be withdrawing from these three dimensions. It should not even be in these three dimensions."

I said, "Wow!"

He said, "Dave, you have to devise an experiment where you can do this: while it is not there, pass an arm through the sample pan. If it is there and resonating at a frequency that you don't perceive, you knock it out of the pan—because when you cool it down and it begins to reappear, it always appears in the same shape and place it was in before it left. That's proof that it left these three dimensions." And he said, "Dave, if you do that, you will never ever want for money."

In 1988 I not only filed a patent on ORMEs [Orbitally Rearranged Monatomic Elements], I filed patents on S-ORMEs, the resonant coupled

quantum oscillating system of many atoms of these ORMEs. I have 11 patents on ORMEs and another 11 patents on S-ORMEs. I have 22 patents.

So, what are some of the other aspects of a superconductor? How do you prove a superconductor is a superconductor? You literally take a constant magnetic field and you pass the material into the constant magnetic field.

If it's *not* a superconductor, if you apply a magnetic field you get positive inductance. If you graph it—applied magnetic field vs inductance; magnetic field vs inductance—and if it's a perfect insulator, you'll run totally parallel. No matter how much magnetic field you apply, no inductance. If it's a perfect conductor, just the littlest amount of magnetic field on it will make the graph go straight up.

If it's a superconductor, as you apply a magnetic field it goes negative. It literally eats the magnetic field. It feeds on the magnetic field and takes it inside itself. Negative inductance in a positive-applied magnetic field is the proof of a superconductor.

In other words, if you had a machine that was a superconductor, when it passed by ordinary power lines it would cancel the voltage potential of the power lines; or, if it passed by a home that had electrical appliances, it would literally turn them off or cause them to flicker and go off.

Do you realise that if you had a machine that could do that, it could literally move in space-time? As Hal was saying, it could disappear and reappear in space-time. It could withdraw from these three dimensions into a fifth dimension where there is no distance and there is no time between here and other star systems, and then reappear out of that in that star system. Have you ever heard of anything that does that?

Anyway, the material is very, very important. The way it works is very, very important, because we are talking about controlling gravity and controlling space-time.

Now, let me give you an analogy. If it is possible for me to shrink your molecular body small enough—miniaturisation that would make you so tiny that you could climb inside an atom—you'd be down in the world of the quanta where there is no time forward and there is no time in reverse. Everything is interchangeable. There is no time as we know it. You would become an immortal. You literally could live forever in the world of the quanta.

A superconductor is billions and billions and billions of atoms all acting like one big macro atom. And so, literally, you make yourself a vessel that you can climb inside of which superconducts, and you energise it and exclude all external magnetic fields including gravity. And you are now in this world but you are not of this world. Hear me. In this world, but not of this world. So, just by heating it you can disappear from this space-time; just like that, gone. Now you will still be able to see everybody there, but they can't see you any more. It's like being above the water and looking down in the water at the fish. You're not in their world, but you can see them.

[Someone from the audience interrupts with a comment.] "But

you wouldn't have any thoughts either because they produce electromagnetic fields."

[Big silence from Dave Hudson. Then person in the audience makes another comment.] "You would just have pure awareness." "That is correct." [Dave remarks, then continues his talk.]

As you can see, this becomes very philosophical very quickly. We decided, "Well, gee, if we have this analytical capability and we can quantitatively and qualitatively analyse this stuff, where else is it?"

So we went down to A. J. Bayless and got ourselves some cows' brains and pigs' brains. We carbonised these brains in fuming sulphuric acid. That was a really raunchy thing to do but it was the only way we knew to do it. We weren't organic chemists; we were inorganic chemists, so we destroyed the carbon, carbonised it, added nitric-nitric-nitric acid, kept taking it down to fumes of sulphuric, then more nitric, fumes of sulphuric, more nitric 'til we got rid of all the carbon. Then water, water, water 'til we got rid of all the nitrous compounds. Then we did a metal sulphate analysis.

Do you know that over five per cent by dry matter weight of the brain tissue is rhodium and iridium in the

high spin state? Do you know that the way cells communicate with each other is by superconductivity? The US Naval Research Facility knows that the way cells communicate with each other is by superconductivity and they have actually measured it using SQUIDS— Superconducting Quantum Interference Devices— with a superconducting ring around the body. By this procedure they have seen that light literally flows between cell to cell to cell to cell.

Do you know that your nerve impulses are not electricity, but that they travel closer to the speed of sound than they do to the speed of light? Electricity travels closer to the speed of light. Do you know at what speed the superconducting wave travels? At the speed of sound.

This is, in fact, what is in your body that we call *consciousness*.

It's what separates you from a computer. It literally is the light of life. This is that part of your body that has been there all of this time, that scientists can't find because their instruments can't see it. They call it carbon because it has no absorption or emission spectra and they assume therefore that it is carbon when, in fact, it isn't carbon. There are 11 elements that it could be, but primarily rhodium and iridium are the elements that are in your body right now. They resonance-connect and literally flow the light of life perpetually in your body.

Around your body you have a non-polar magnetic field which is called the Meissner field—also referred to as the aura. These are literally the spirit atoms in your body. These are the atoms that are in resonant harmony and resonating with the vacuum energy, and the vacuum energy is another dimension where

**"So, just by heating it you can disappear from this space-time; just like that, gone. Now you will still be able to see everybody there, but they can't see you any more."**



there is no time. Everything that ever existed and everything that ever will exist is registered in the vacuum. And I will tell you now, my friends, that when you meet your God, you will meet him in the vacuum. That is where all matter came from, that is where all matter originated and that is where everything is recorded. And your connection is through these resonant oscillators that are in quantum resonance with the vacuum energy. That is what brings the light of life from the world of the quanta up into the macro body you call your own physical being.

These atoms, in a macro state and dried, look like a white powder. But actually, if you look at them under a microscope, they look like glass. You can heat the white powder to 1,160 degrees under a vacuum and it forms a glass, just like window glass. It is another form in which the element can exist.

You come to understand that each of these atoms is resonating with the vacuum energy. You can't harness a single atom. You can't put reins on it and say, "Work for me!" This is a perpetual-motion machine. When one atom is resonating back and forth in two dimensions, it creates a quantile wave that comes off it. The next atom nestles into that wave and perpetuates the wave. The atoms are actually too far apart to have any chemistry, and yet they are sitting at a distance, resonating in perfect unison, in harmony. The energy literally rolls around one atom for ever and ever and ever. Have you ever asked yourself why an atom never runs down? It is because it is dipping into the zero-point energy all of the time.

So now you have each atom in resonant harmony with each other; each atom dipping into the zero-point energy. You've got billions and billions and billions of them doing it for you. What you now have is a perpetual-motion machine. You have something that is running perpetually on zero-point energy.

You can actually build a ring of this material and it will flow and respond to the Earth's magnetic field. For example, do you know that a single-element superconductor, a type-one superconductor, will literally respond to a magnetic field of  $2 \times 10^{15}$  ergs? Do you know that there are  $10^{18}$  ergs in a gauss? Do you know that the Earth's magnetic field, with which the compass aligns, is about 0.5 gauss? So an erg is the measure of the magnetic field around one electron. And a superconductor responds to a magnetic field of  $2 \times 10^{15}$  ergs. Gosh! When you think, it registers. So when you are working with this material, your thoughts are registering in the material.

In fact, some of you women will get upset with me when I say this, but we actually came to know these as female elements. What we did is we said, "You know, we're going to flip these

things. We're just going to overcome these things, 'cause if you just put enough energy to them you can make them do what you want, right?" Sure.

We purchased what is called an arc furnace. We took about 30 grams of this white powder and put it in the furnace. This furnace has an insulated crucible which has a copper crucible inside it with water all around it to keep it cool. You bring a lid down on top of it and there's a tungsten rod that hangs down into it. It actually runs a little arc welder which you strike from the tungsten electrode to the copper. And in this arc you sit there and you stir with the electrode back and forth, back and forth 'til you literally melt everything that is there.

Now what we did was we pumped out all of the air, we back-filled it with helium gas for a plasma gas, and we struck the arc. It went 'bzzp', like that, and shut off. We opened up the arc furnace: no tungsten electrode. Now this tungsten electrode is about the size of my thumb. Tungsten is the filament material that they use in making light bulbs. The people who built this furnace said we could use it for 35 to 40 times with no deterioration of the electrode. We could burn it for minutes and minutes and minutes and minutes. We didn't even get a second out of this thing! So we got another electrode from the manufacturer, put it back in, closed the furnace back up, vacuumed the air out, put in the inert gas, struck another arc, then 'bzzp', it shut off. We opened it up to find that the tungsten electrode was all molten into this powder.

When we analysed the powder after we did this, we found that it wasn't the same element it was *before* we did this. We also found that there was an amplification of heat by about 2,000 times. It was not chemical heat; it was *nuclear* heat.

What we found was that all the wiring in the laboratory was beginning to crumble and fall apart. We could go up to the copper wires and they would just go to powder. The glass beakers sitting in the laboratory near the furnace were getting full of little air pockets in the glass, and when we picked them up they would fall apart. That's radiation damage. There is no other explanation for it. Berkeley-Brookhaven has confirmed a level of 25,000 electron volt photons.

Gamma-level radiation comes out of these high-spin atoms when you throw too much energy at them. So, like all females, if you tell them you will force them you will get absolutely nothing, but if you give them what they want, they will give you what you want! So you cater to these elements; you don't fight these elements. These elements are alive. And what you have to do is give them the chemistries that they want, cooperate with them, coerce them and they will literally go back to the low-spin state.

You can make them into metals or you can use them in the high-spin state.

Now everything was pretty interesting until, in 1991, my uncle came up with this book called *Secrets of the Alchemists*.<sup>2</sup> I said, "I'm not interested in reading about alchemy. This was when the Church was involved in it and everything. This was all perverted. I'm not interested in that. I want to know about chemistry and physics."

He said, "Dave, it talks about a white powder of gold."

I said, "Really?"

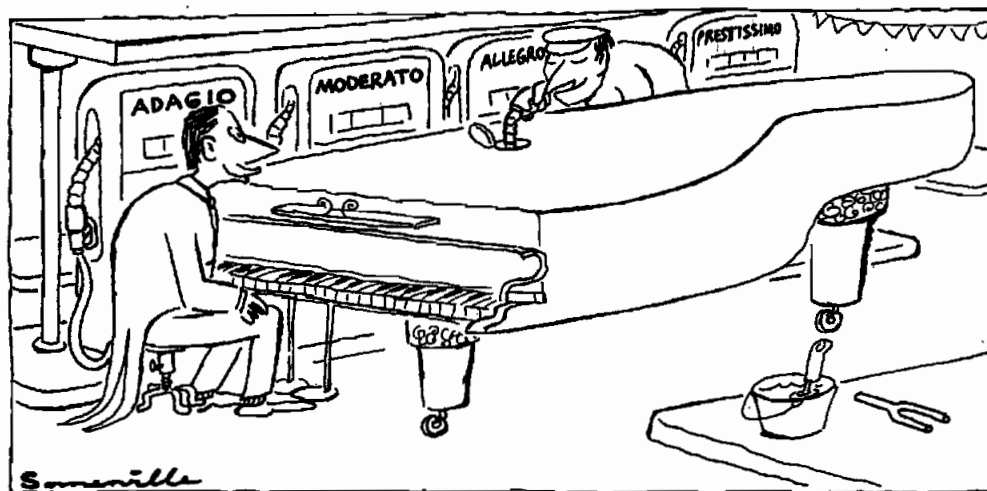



And so I began to look into alchemy. And the 'Philosopher's Stone', the container of the light of life, was the white powder of gold.

I said, "Is there a chance that this white powder of gold that I have, could be the white powder of gold they're talking about? Is it possible that there are two white powders of gold?"

Now, the description says it is the container of the essence of life; it flows the light of life. Well, that we had proven. It's a superconductor. It flows the light that is in your body. They claimed that it perfects the cells of the body.

Well, I can show you Bristol-Myers-Squibb research on how this material interacts with DNA, correcting the DNA. All the carcinogenic damage, all the radiation damage, all is corrected from these elements in the presence of the cell. The elements don't chemically interact with it; they just correct the DNA.

I really became intrigued with this stuff. What would happen if we gave this material to people? It's not metal-metal bonding, so it doesn't have heavy-metal properties.

First of all, we got a golden retriever and gave the material to him. This golden retriever had tick fever, valley fever and a large abscess on his side. None of the veterinarians could find any medicine that would get rid of the abscess due to the combination of all three diseases, so they just gave up; they weren't going to cure him. We began giving him one-cc injections of one milligram of the white powder—one shot in the tumour and one shot in the bloodstream. After a week and a half the tick fever was gone, the valley fever was gone, the tumour shrank and disappeared. So we stopped the injections. About a week later it started coming back again, so we started giving the injections again and the tumour shrank back down. This time we continued about a week longer and then, when we stopped, it never came back. The dog felt great!

Then the doctor we were working with said, "You know, this is really incredible stuff!" He said, "I have a patient who is a day or two away from death with AIDS. He is being fed intravenously right now. He can't speak, he can't dress himself; he is dying. So I'm going to start giving him just a little bit of this material and see what happens."

A week and a half later he pulled all the feed-lines out of his arms; he was feeding himself normally, getting dressed on his own, just doing great. A month and a half later he was on an airplane going back to a family wedding in Indiana, and nobody even knew he had AIDS.

This doctor said, "Dave, this is like a magic material!"

So he got a patient who had KS [Kaposi's sarcoma] which is the cancer you get all over your skin. This man had over 30 lesions all over his body and we began to give him one-ml injections into his bloodstream. After a month and a half there was no more active KS on his body. One milligram per day!

Now, if you are familiar with KS there is only one treatment, and that is radiation treatment. And after a while you get the maximum amount of radiation and they have to discontinue the treatment; then you get worse and die. And this material totally got rid of KS lesions!

Then we started working with another patient who was actually not gay. This woman had received the AIDS virus in an *in vitro* fertilisation that was done down at the University of Arizona. There were 10 women who received the semen from this patient who had HIV, and she was the only one who got AIDS. She's had it for 11 years. She was really starting to go downhill. Her white blood cell count and her T-cell count were really classic.

We gave the material to her orally for the first time, and basically there was no change in her white blood cells or in her T-cells.

Now, when we give it by injection, the white blood-cell count goes from 2,200 to 6,500 in an hour and a half! Unbelievable! When it's taken orally, nothing happens to the white blood-cell count, which was our only analytical battle.

After a month she said, "I want the injection; I want to see this increase my white blood cell count."

So we prepared her a shot and she took the material by injection. At the same time we gave her the shot, we pulled blood samples and sent them to KNOWING Laboratories in southern California for an analysis of infected virions per millilitre of blood.

She took the first injections. She got high fevers, just like everyone does, so we said to cut the dose in half. So her doctor cut the dose in half, but the next day when she took it she went into seizures and died. By that time we got our analysis back from KNOWING Laboratories, which said that the infected viron count was so low that this woman shouldn't even know she had AIDS. Now, we didn't do an analysis upfront, so we decided, "Well, we'll start giving this to people *after* we do a lab analysis."

We worked with a man who had an infected viron count of 57,000. He was so weak that he could hardly walk; he used a cane.

His doctor gave him two to three weeks to live. He took this material orally, and it took about 60 days for the infected viron count to begin to drop. After 60 days, it went down 30 per cent every 30 days. By the end of seven months it was so low they couldn't even detect any more virions in his blood. And that's taking 50 milligrams per day orally.

Now, do understand, I'm not a doctor. I have no interest in becoming a doctor. What I wanted to know was, "Is it possible that this stuff works?" That's all my interest was.

There was one doctor in North Phoenix to whom I gave two bottles of the dried material and he gave it to two cancer patients. One was 42 years old and the other was 57 years old, and both had breast cancer.

The 42-year-old woman had had a breast removed two years earlier and had undergone extensive radiation treatments. After two years she was having pain in her neck and in her ribs. She went to a chiropractor, but that couldn't help her. She finally ended up seeing an oncologist who said she had cancer in her neck, her shoulder, her back, her spine and her ribs.

He said, "It is stage four. Get your affairs in order. We can give you chemotherapy but you are going to die."

"...the  
'Philosopher's  
Stone', the  
container of the  
light of life, was  
the white powder  
of gold."

Continued on page 89



## A WATER-FUELLED CAR

by Carl Cella

I am the madman behind the US heavy-metal band, "Rampage", but long before my musical success I was mechanically inclined, and the possibility of running a car on fuel extracted from water intrigued me no end.

After reading all the information I could find on the subject of hydrogen generators, I built my first actual unit in 1983, mounting it in the trunk of a 1979 Cadillac Coupé de Ville.

I constructed my system from the best of all the other systems I read about, and then went even further, using the strongest materials and cleanest layout possible within reason. All the titanium nuts and bolts were scored from an aircraft salvage supply: they're cheaper, used, and since they'll never wear out that's one way to save some big bucks. Certain head and exhaust system modifications have to be made to expect trouble-free extended use. For one, the combustion of hydrogen results in the rebonding of the previously-separated hydrogen and oxygen molecules, making the engine's exhaust water vapour steam, and nothing else—meaning absolutely no pollution at all!

Most auto-makers use cast-iron exhaust manifolds and steel valves. The combined effects of heat and moisture (moisture not being present in the combustion of petroleum-based fuels) cause extremely rapid corrosion of the system. Part of the fix is to install stainless-steel valves and an exhaust system constructed entirely out of stainless steel. Racing shops sell stainless-steel valves and stainless-steel 'turbo' mufflers that all work fine. Since hydrogen does not contain lead as some gasoline does, if you're not using a late-model, no-lead engine, the heads will have to be reworked to include valve seats not needing the lubrication lead provides.

As for building this device to sell as a completed system, that's a dead issue. In 1983, I contacted the Department of Energy to show them that my car actually worked. I was confronted by two very belligerent 'agents of tyrannical oppression' who told me that if I tried to sell pre-built

units, I'd have a lot of "problems". I asked why, demanding an explanation, and was told very bluntly, and not in a very nice tone: "Do you have any idea what a device like this, available to the public, would do to the economy?"

This technology is so simple that anyone with over half a brain—and knowledgeable in auto mechanics—can build one of these units. I've included comprehensive, no-bullshit, drafted design layouts, parts lists, maintenance tips, and a whole lot of engine modification concepts to make construction, part fabrication and implementation as easy as reasonably possible.

The unit I built works as great as I claim it to, but I offer only the printed information on how to build your own, and I take no personal responsibility for damage of any kind caused to your vehicle or self. (See schematics on follow-on pages.)

I have only applied my unit to a carburetted engine; I've never attempted an application to a fuel-injected engine, nor do I make any such claim that an application of that type would be easily performed, if possible at all. *Every cubic foot of water contains about 1,376 cubic feet of hydrogen gas and 680 cubic feet of oxygen.* Because there is no pollution produced, all smog devices may be completely removed, legally, and your car exempted from smog checks, as are propane-powered vehicles.

The only maintenance I've encountered is, periodically, to wire-brush mineral deposits off the reaction chamber electrodes and, at longer intervals, to clean out the chamber itself—neither of which is complicated or very time-consuming. I've incorporated so many backup electrodes so this job won't be required roadside—as it was for me when I first used only one, not knowing about any deposits entirely covering the electrodes and thus halting the electrical reaction process. When the car dies out, you just flip another switch until you're somewhere able to brush the reactor's electrodes clean in reasonable comfort—and not northbound on Highway 5, halfway between Los Angeles and San Francisco, where my first breakdown was.

Where the steel gasoline tank used to be, a plastic water tank is fitted, along with an electric float sensor that should be attached

to the vehicle's existing fuel gauge. If you were to start your engine with no modifications other than the carburettor to accept hydrogen fuel, it will run fine but the exhaust system will corrode in almost no time, and if you leave the engine turned off for an extended period, your stock valves and guides will rust up and seize!

Stainless-steel valves don't cost much and are as trouble-free as the stainless-steel exhaust system, so don't be a fool and try to go cheap because you'll only cause yourself added expense and headaches, and you'll be cursing me for your own stupidity. For the cast-iron combustion chambers and valve ports, there is a high-temperature ceramic coating called "heanium" that can be preformed to guard against the same corrosion that affects the valves, guides, exhaust system and also the intake manifold, as moisture down there will also cause corrosion.

Petroleum-based fuels have their own detergent action that protects against corrosion, much like soaking parts in oil prevents corrosion. When using hydrogen as an internal combustion engine fuel, extra precautions must be taken to make extended operation a reality, and not some drive-a-few-thousand-miles-between-fried-engines bullshit.

Don't use sea water! It contains approximately three-fourths of a pound of salt in every gallon. Salt is a material that will coat the electrodes very quickly, just making one big mess. The reason for electrode deposit buildup is that tap water is never 100 per cent pure: it contains mineral contaminants that are drawn to the reaction-chamber electrode during the electrically-activated molecular separation process, that results in the hydrogen contained in water being released from the oxygen molecules they are bonded to, making a fuel that can power an internal combustion engine.

I offer no design for an exhaust steam condenser, but I do make the suggestion that one applicable to an automobile can be built to increase the cost-free mileage even further between fill-ups. A concept would include some form of exhaust-fed radiator that could incorporate air ducts, leading from scoops, to direct highway speed airflow across it.

I offer the idea, but not the design,

because many aspects must be considered, such as: the least amount of back pressure, unit pressure; unit placement with regard to configuration by the limit or abundance of that space—though this one would be constructed for a stationary, engine-powered electrical generator, where space limitation is of no concern.

Remember, the cylinder walls are cast iron and prone to rust, but they can be kept clean by piston action (as long as it's not left sitting for long periods between use).

An automobile engine could feasibly be constructed with non-corrosive stainless-steel heads and cylinders straight from the factory—a solid reason to justify spending twenty-five grand or more for a car, because the fuel to run it would be free.

There has been much criticism over hydrogen as an auto fuel, most of it coming straight from those who have the most to lose if hydrogen ever achieves widespread use as an automotive fuel.

There are some factory-built high-performance cars on the market that already come with stainless-steel valves, but they are few and far between, and you still have to change the exhaust systems.

For the carburettor to accept a vapour-state fuel, it must be converted using the same parts that are used in propane/butane engine fuel systems, such as carburettor kits by "Impco", or similar, that do the same thing, i.e., enable your engine to be powered by a vapour-state fuel.

Because no pollution is produced, the engine may be rebuilt 'legally' with higher performance parts, like a camshaft that, on gasoline, would have increased exhaust pollutant emissions, thus making it 'illegal' for highway use. Of course, it's only a 'crime' if you get 'caught', but those pay-again-every-time-your-vehicle-fails smog checks are a pain in the ass, not to mention the wallet.

A similar type of mechanism that opens and closes retractable headlights could be implemented in a dashboard switch-activated system that could open a trunk lid-mounted scoop that captures rain, with a flexible hose line that directs it into the main tank, either while the vehicle is in motion or parked. Just watch the fuel gauge, and close the scoop when you see "Full"!

While it may be a long time before we are able to purchase an entirely corrosion-resistant, exotic alloy engine, I am offering the complete design for a hydrogen generator that will power a car—but any engine modifications I outline are only given as

basic concepts. It's up to you to implement what is applicable to your particular engine. Use some initiative. Don't rely on whether I wrote it or not. If you discover a part or a process that I haven't mentioned, that will in any way protect your engine further from the effects of corrosion, use it! I've written this to help people wake up from the big lie of having to depend on oil companies just to drive a car.

Building as many units as I can for personal use only, and writing this booklet, are about the only things I can 'legally' do to try to help the world wake up. A hydrogen generator produces an energy potential in excess of 100 per cent efficiency!!! You read it right: free energy!

A car's battery starts the engine, but once it's running, the alternator takes over to charge the battery and power the ignition system. With an onboard hydrogen generator, that alternator also powers the hydrogen extraction process, producing the energy needed to fuel the engine that runs the alternator. No external power source is needed; so as long as there is water available, the entire system is self-sufficient in operation. An extra trunk-mounted battery would provide more current—if ever needed—to run everything at once without overloading the electrical system.

## System Operation

The dash-mounted switches for turning on the reactor are also wired to activate the chamber feedwater pump at the same time. When the car dies out, that signals to you that an electrode has been totally crusted over with deposits from the impure fuel water. This means the electrically-activated molecular separation process (electrolysis) has halted. These switches should also have indicator lights to let you know which one is on, and flip-up caps to guard against accidental activation.

When the need arises to go to backup, turn off the switch for the 'dead' electrode, as well as close its electrical shut-off valve. The purpose of these gas valves is to keep pressurised oxygen from escaping up through the 'off' electrode fittings into the hydrogen lines, possibly resulting in your car becoming a "Highway Hindenburg"!

Hydrogen is separated from its molecular bond with oxygen by exposing the fluid of water to direct-current voltage. Hydrogen is attracted to a negative charge, while oxygen is attracted to a positive charge. This process generates heat in the chamber, so trunk placement is best with an aluminium or plywood wall built between the reactor

and the rest of the available trunk space. Small cars are light on gasoline, thus cheaper to operate, but when all of a sudden the fuel becomes free, the size and weight of the car is of no concern, except for Porsches and similar sportscars, street rods, etc.

Water is pumped through the reaction chamber, which itself is positively charged, drawing the oxygen molecules out through the water return line to be vented off through the water tank's cap. The hydrogen-attracting electrode extending into the welded-in pipes (and insulated under the T-fitting) is negatively charged. There is a dash-mounted pressure gauge that is connected before the regulator and mixer. To begin hydrogen generation, flip one of the dash-mounted switches and wait for the gauge to show fuel-line pressure; then start the engine when pressure is shown by the gauge to exist. In mounting the unit, remember that the chamber itself is positive, and most cars use a negative chassis ground, so insulated mounts must be fabricated between the positive chamber and the negative trunk-floor.

As a final note, this unit is not a concept or a theory! It is tried and proven! I designed this system at age 18 in 1983, and built more than one, using Rampage profits for research and development.

I can't sell actual working units, but nothing but death itself can stop me from distributing this information in the hope that people will take the initiative to wake up from the big lie of oil-dependency for auto fuel, and flood the street with hydrogen-powered cars.

If enough people find out how simple it is, public pressure may someday soon be put on the government, resulting in the long overdue media exposure they're all so afraid of. *Eyewitness News* (Channel 7) in Los Angeles didn't want to let the word out that an actual working vehicle had been built by an 18-year-old metalhead! We're supposed to be stupid in the public's eye, from their point of view!

Hydrogen and oxygen gases do not pollute; they help clean out carbon deposits from the engine for better mileage and less engine wear. You'll notice the improved engine performance immediately.

(Source: Carl Cella, PO Box 8101 (4176-X), San Luis Obispo, CA 93409-0001, USA.)

Originally published in *Iron Feather Journal* #13, PO Box 1905, Boulder, CO 80306, USA, and then in *Psychedelic Illuminations VIII, Fall/Winter 1995/96, PO Box 3186, Fullerton, CA 92634, USA*)

## Do-It-Yourself Special Feature: MODIFY YOUR CAR TO "BURN" WATER! - - Technical Diagrams (reproduced exactly as we received them)

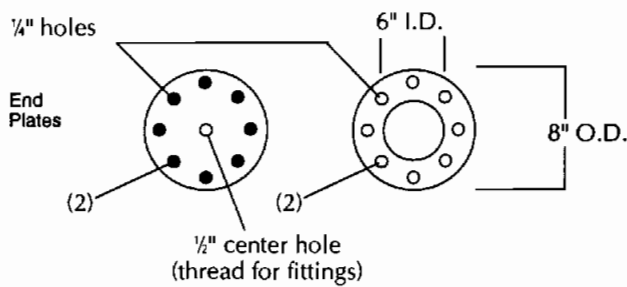
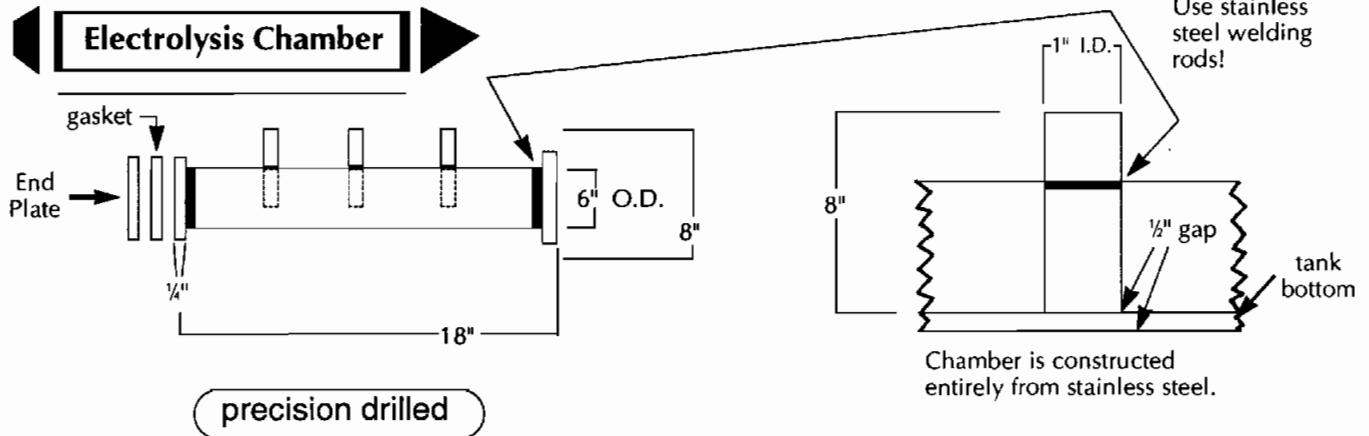

### Get the materials listed below!

- (1) 18" x 6" O.D. x 1/4" stainless steel pipe
- (3) 8" x 1" I.D. x 1/8" stainless steel pipes
- (2) 8" O.D. x 6" I.D. x 1/4" end flanges
- (2) 8" x 1/4" end plates
- (16) 1" x 1/4" aircraft salvaged titanium bolts
- (16) 1/4" aircraft salvaged titanium self-locking nuts

For the vapor fuel conversion parts:  
(fuel mixer, and low pressure regulator)  
IMPCO CARBURETION  
16916 Gridley Plaza  
Cerritos, CA 90701 USA

## HERE'S How:

### Hydrogen Electrode Fabrication (Exploded View)

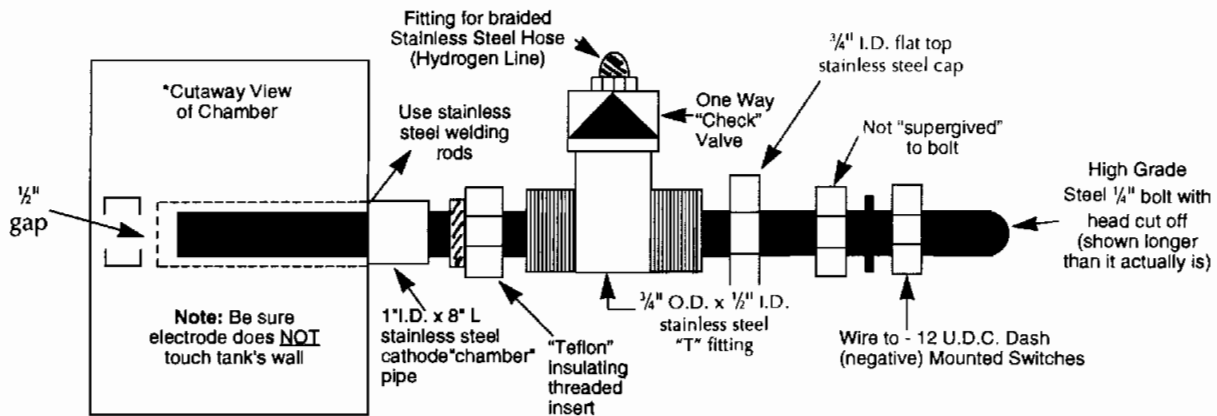

Hydrogen burns slightly hotter than gasoline

### KEY:

- O.D. = Outside Diameter
- I.D. = Inside Diameter
- V.D.C. = Voltage Direct Current

## HYDROGEN GENERATOR INSTALLATION

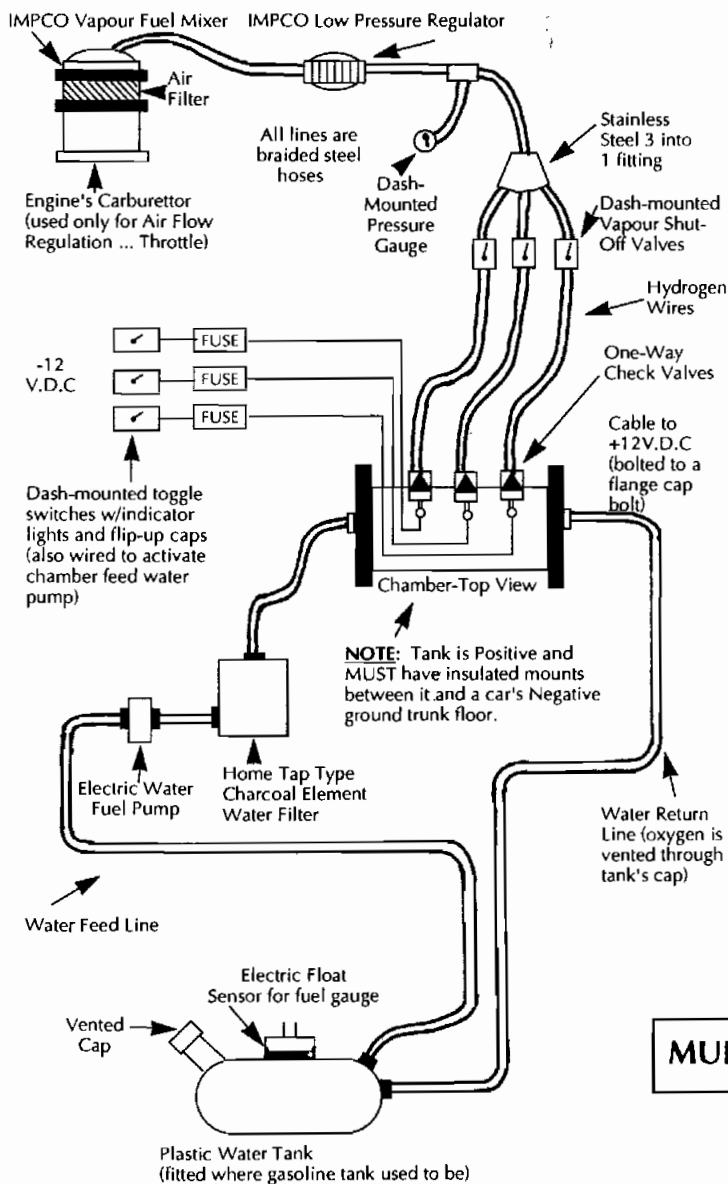

## GENERAL PARTS:

- Stainless Steel Valves
- Bronze Valve Guides
- Stainless Steel Piston Rings
- Stainless Steel Headers
- Stainless Steel Mufflers
- Stainless Steel Exhaust Tubing

3/8" 'Teflon' Core Braided Steel Hose (Buy a roll - you'll need a lot!)

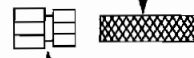

Stainless Steel Swivel Fitting Connectors (Screw Over Hose!)

\* Stainless Steel Dual Exhaust System (Headers)

\* Electric Muffler Drain/Water Recovery Pump fed back into Main Tank ("T"-fitting between both stainless steel turbo mufflers using heat-proof braided steel hose)

**NOTE:** The combustion of hydrogen results in the reformation of water. The engine's exhaust is water vapour **steam**. Some of this **steam** condenses into water, collecting inside the mufflers. This system recovers the water content of these mufflers.

## MUFFLER WATER RECOVERY SYSTEM CONCEPT

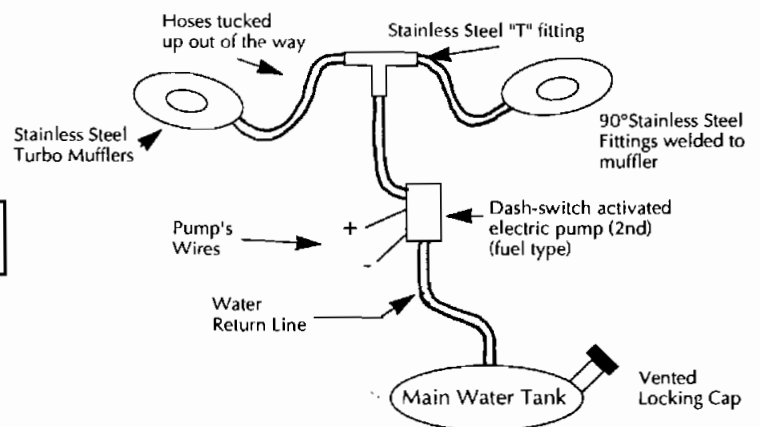

## CHAMBER MOUNTING IN CAR'S TRUNK

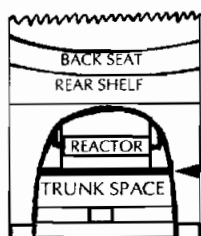

Tank is Positive, and trunk's floor is Negative (Ground), so use Insulated Mounts.

Plywood or Aluminium partition between reactor and remaining available trunk space.







# — CEREAL THRILLERS! —

## The Crop Circles of '96

*England's crop circles are back again, and this season's designs are bigger, more bountiful and more beautiful than ever.*

*But who or what made them, and what do they mean?*

by Marcus Allen

NEXUS Magazine (UK Office)  
55 Queens Road, East Grinstead  
West Sussex RH19 1BG, UK  
Telephone: +44 (0)1342 322854  
Fax: +44 (0)1342 324574

Photographs by Stephen Alexander ©1996

There are always doubts. Every April, the same question is asked among crop circle enthusiasts: "Will there be any formations this year?" 1996 was no different. Winter was long in England, and spring was wet, but by mid-May the question was answered: "They're back again."

As usual, the season started the same way: a few simple circles and rings in a variety of crops—oilseed rape, barley and wheat. By mid-June, nothing special had been reported to the only monthly crop circle publication, *SC (Sussex Circular)*, which had just six circles listed.

On the morning of Monday 17th June, everything changed. One of the most spectacular designs ever to appear was seen in East Field, Alton Barnes, Wiltshire—the site of numerous formations in previous years, but none so intricate as this. Immediately named "DNA" from its obvious similarity to the DNA double helix, the formation measured 648 feet in length and consisted of 90 separate circles ranging from two feet to 50 feet in diameter. The 'tramlines' were about 50 feet apart, made by tractors carrying crop-spraying equipment with booms extended on both sides. Farmers in England very rarely use aerial spraying.

Enquiries by the many crop-circle researchers already packing out the legendary Barge Inn at Honeystreet—the ultimate destination for any self-respecting 'croppie' (see NEXUS 2/28)—soon established some important details. East Field had been watched until 1.00 am that morning; no one had been seen to enter. Dawn was at 4.30 am. The formation was first reported at 6.30 am by an employee of the farmers, Tim and Polly Carson.

Ground inspection revealed beautifully swirled circles, with no damage to the crop other than that it now lay horizontally. Aerial photographs were taken by 10.00 am and showed the truly spectacular nature of the design.

Several national newspapers in England carried large pictures of the "DNA" formation, with reports which reflected the genuine bewilderment felt by many as to its creation: 90 circles in less than five hours (one every three minutes!), no mistakes, and mainly created in darkness. The Carsons issued a challenge: "If anyone can claim to have made it, then do it again alongside the original." No one came forward.

Due to the indefatigable work of Peter Sorenson from California, who has faithfully videotaped most UK crop circles since 1992, the "DNA" formation was filmed from the air and from the ground. News of the formation was soon on the Internet. The Crop Circle Connector site has details and pictures of all formations reported.

Whoever or whatever the Circlemakers are, a sense of humour seems part of the phenomenon. As if to say, "So you thought the DNA formation was good? You ain't seen nothing yet!", more was to come.

On Sunday 8th July at 5.30 pm, an air taxi pilot flew over Stonehenge. The passengers wanted to film the world-famous stone circle. No one reported seeing a crop circle. Yet, by 6.30 pm, people were already trying to enter the formation, soon to be named "the Julia Set" (a mathematical diagram which results from running fractal equations on a computer, in a similar way to the Mandelbrot Set).

The formation was 400 yards south of Stonehenge and within sight of the main London-Exeter road (A303), one of the busiest holiday routes in England. Consisting of 151 separate circles from two feet to 40 feet in diameter, and measuring 915 feet long when unravelled, "the Julia Set" became more mysterious, with investigations being conducted by Colin Andrews and others.

The formation was within sight of the 24-hour-a-day security guards at Stonehenge who reported seeing nothing unusual. It was a few miles from not only the RAF airfield at

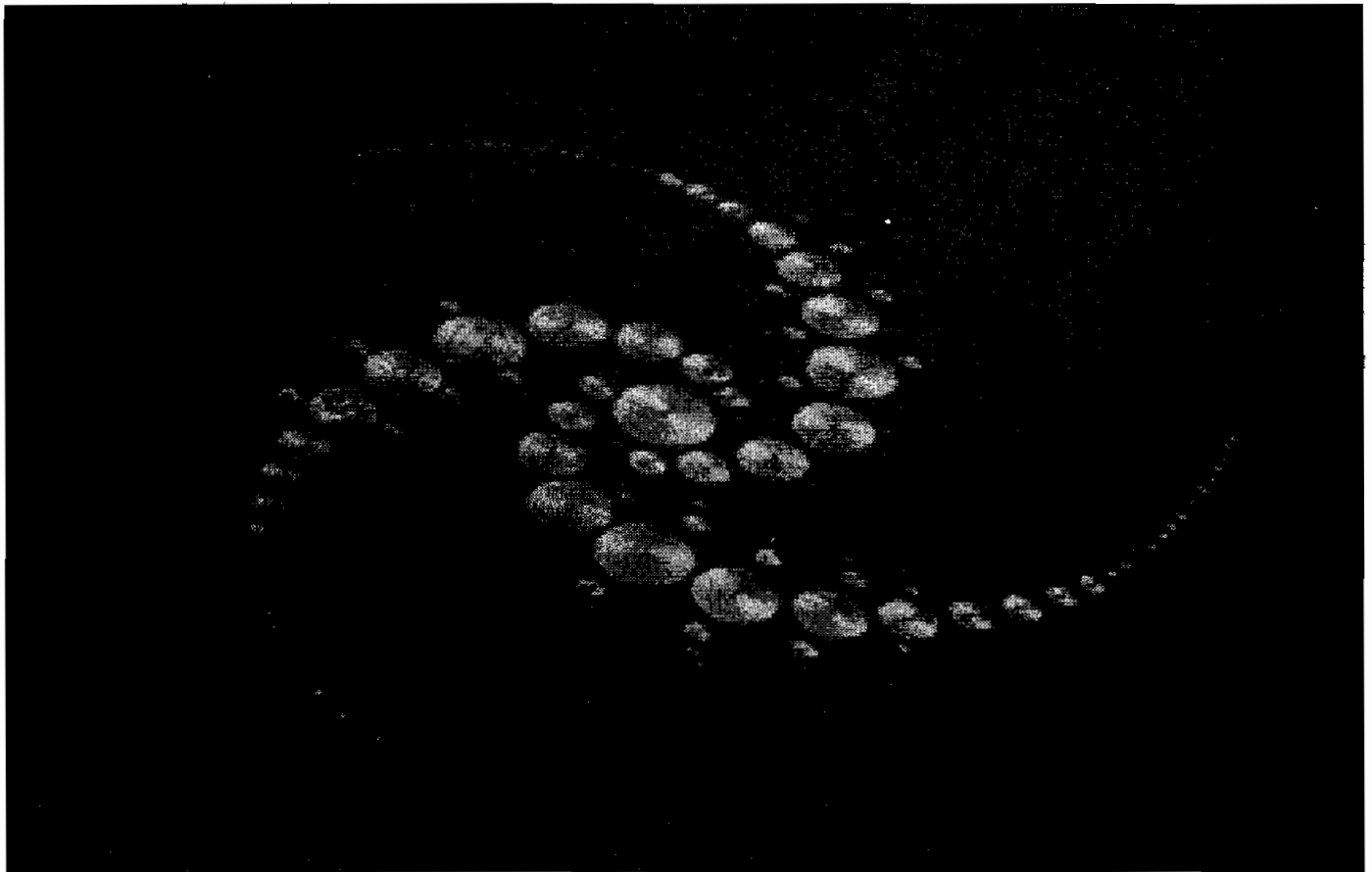

**29 July 1996: Triple-Armed Spiral, Windmill Hill, Avebury, Wiltshire, England**

Boscombe Down but also one of the many Army bases on Salisbury Plain at Larkhill, both of which claimed nothing out of the ordinary had been observed.

From ground level, "the Julia Set" was too large for anyone to grasp the scale and intricacy of the layout. Only from the air could its staggering complexity and beauty be fully appreciated. As all the evidence appeared to indicate the formation was created in around 30 minutes, human involvement in its creation becomes untenable (one circle every 12 seconds!).

Initially the farmer, Philip Santel, was very angry at the damage to his wheat crop and tried to stop anyone entering his field. After seeing the aerial photographs and recognising the impossibility of keeping out visitors, he reached a solution satisfactory to every-

one: £2.00 and in you go! Signs were soon erected announcing "Europe's Largest Crop Circle". The A303 was frequently at a standstill as thousands of visitors parked, paid their fee and experienced—many for the first time—the wonder of being in a crop circle.

Newspapers and TV again reported this new formation, so adding to the international awareness that an unexplained phenomenon exists. At the end of July the annual Glastonbury Crop Circle Symposium took place, attracting visitors from around the world.

As if emboldened by the resurgence of interest, the Circlemakers continued to come up with yet more breathtaking designs: in particular, the triple-armed spiral at Windmill Hill



**August 1996: Barton Le Clay, Bedfordshire, England**

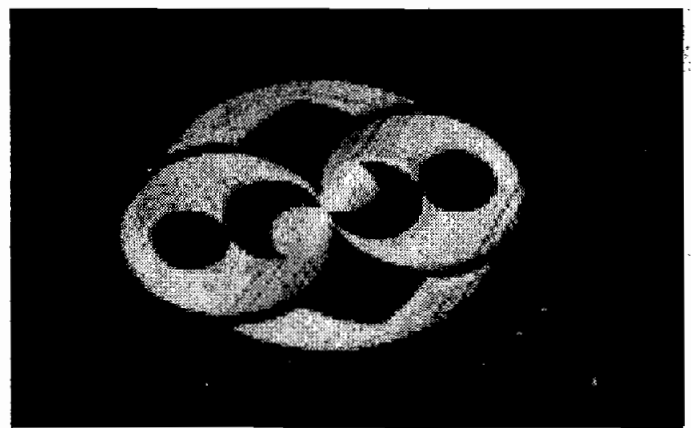

**2 August 1996: Chiseldon, Wiltshire, England**

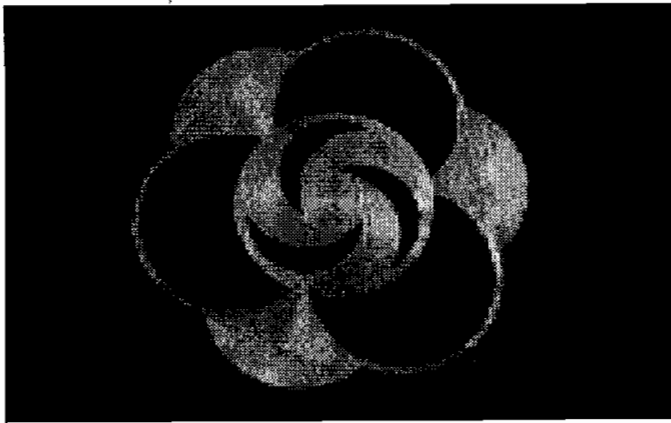

14 July 1996: Little Bury Green, Essex, England

near Avebury, again made up from many linked circles—in this instance, 195—inside each of which remained a small tuft of crop standing in the centre.

By mid-August, over 100 formations had been reported in England, with another 40 from abroad: the USA, Canada, Finland, Germany, Austria, the Czech Republic and Holland.

This year, 1996, is already acknowledged as the best one yet for crop circles. The complexity of formations and the sheer mystery of their origins has only added to the interest of increasing numbers of people trying to make sense of the world around them. Their investigations have naturally led them to look into other similar areas of mystery and strange phenomena: UFOs, ETs, free energy, hidden history, the Face on Mars, pyramids, Atlantis,



17 June 1996: "DNA", Alton Barnes, Wiltshire, England

etc., and, in doing so, they have not only met others with similar interests but discovered the huge number of books, magazines and videos already in existence which recount how truly extraordinary events are regularly reported, with convincing evidence showing other aspects of the more usually accepted explanations.

For many, the journey which may have begun with their first sight of a crop circle has already led them to discoveries which have changed forever their view of our planet. It is not only more complex than we can imagine, but far, far more dramatic. ∞

— Photographs ©1996 Stephen Alexander —  
For more details on how and where to purchase these crop circle photographs, phone Steve on +44 (0)1705 352867.

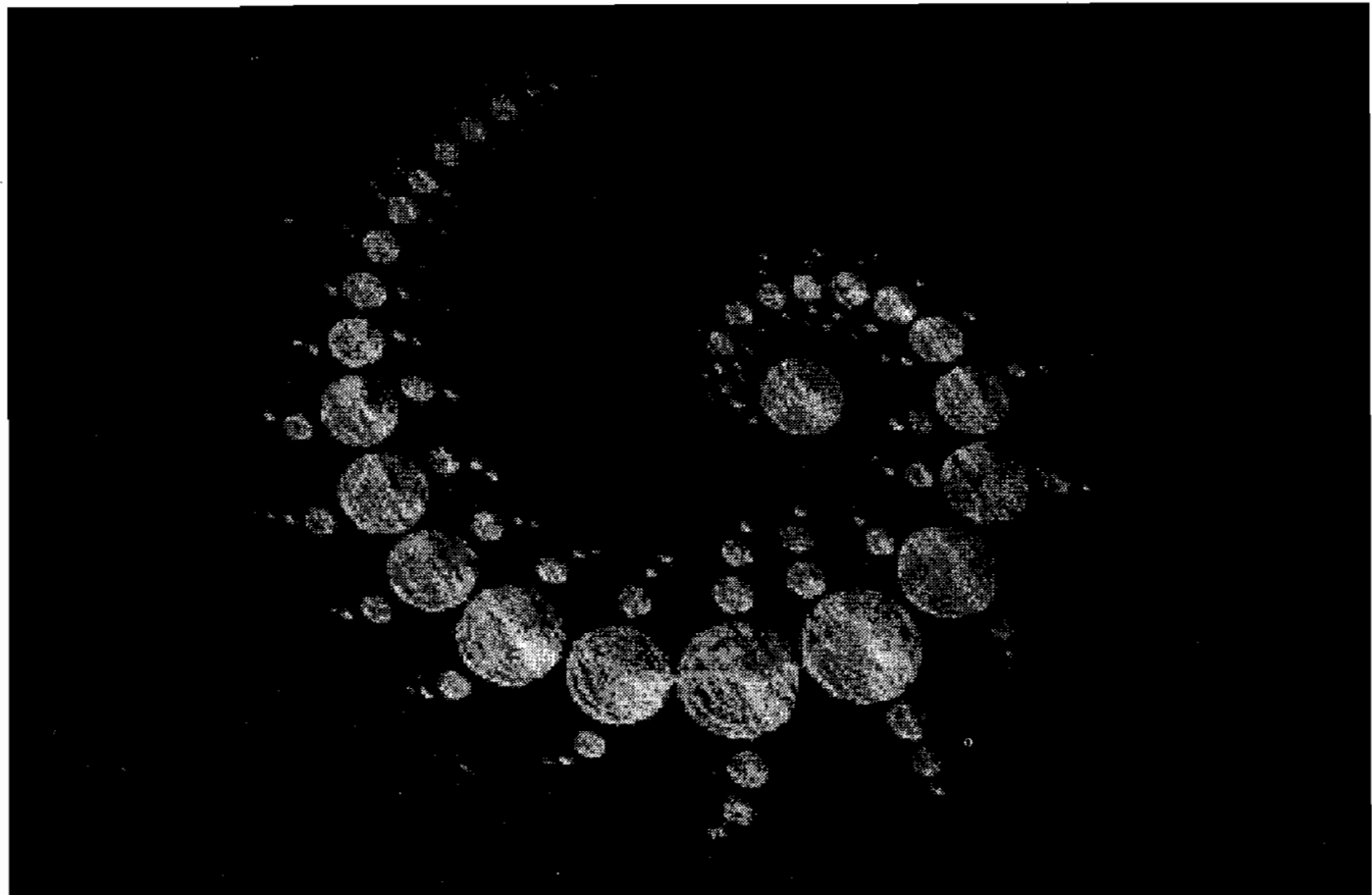

8 July 1996: "The Julia Set", Stonehenge, Wiltshire, England



# THE ALIEN AUTOPSY FILM

## — Facts vs Armchair Research —

*Some international researchers conclude that the Santilli 'Roswell' footage is not a hoax.*

*They claim that the alien in the autopsy room was retrieved not from the Roswell UFO crash site but from another, earlier crash near Socorro.*

by Michael Hesemann

© 1996

Editor/Publisher  
*Magazin 2000*

Worringer Strasse 1  
D-40211 Düsseldorf, Germany  
Fax: +49 (0)211 354893

### THE 'ROSWELL FOOTAGE' RELEASE

About a year and a half ago, on 5th May 1995, the London-based film producer Ray Santilli for the first time presented his alleged alien autopsy footage to an audience of invited media representatives and UFO researchers at the London Museum. Even before that date, a very emotional debate had already started. Angry ufologists had challenged Santilli to shut up or work together with them, while others had claimed from the very beginning that the film is a hoax just because it doesn't fit into their concept of what happened in New Mexico in the summer of 1947.

Santilli's marketing policy, his commercial exploitation of the film, his ignorance in the UFO field and his violation of all the unwritten protocols of the UFO community didn't find many friends among ufologists, and quite soon many screamed "Hoax!" without being able to prove anything. One researcher even concluded, "There is no [16 mm] film and no cameraman", after quoting page after page of all the rumours, second- and third-hand information and inconsistencies among Santilli's claims (or alleged claims), to prove that he was right from the very beginning when he suspected a scam, because the being on the autopsy table looked "too humanoid to be an extraterrestrial", yet ignoring that this is exactly how most eyewitnesses describe crashed ufonauts.<sup>1</sup>

Unfortunately, those who searched for the truth, wherever it might be, were few in number. Willing to listen to Santilli first, before they judged and checked out the information they could get before asking for more, were mainly Philip Mantle (UK), Bob Shell (USA) and Michael Hesemann (Germany)—the International Research Team (IRT)—joined by Maurizio Baiata and Roberto Pinotti (Italy), Johannes Baron of Buttler (Germany), Odd-Gunnar Roed (Norway), Hanspeter Wachter (Switzerland), Col. Colman VonKeviczky, Dr Bruce Maccabee, Joe Stefula, Lt. Col. W. C. Stevens, Ted Loman, Robert Morning Sky, Llewellyn Wykel and Dennis Murphy (USA), and others.

Let me point out that we found Ray Santilli always very friendly, helpful and cooperative although sometimes limited in his actions by agreements with his business partners and the cameraman. I wonder if any 'major international media corporation' would ever have been even nearly as open to any reasonable research approach as Mr Santilli indeed was. The following is a summary of results from the IRT's first year of investigation.

### THE CAMERAMAN

Yes, there is a cameraman. We located people, besides Santilli, who had spoken to him over the phone: Gary Shoefield of Polygram, Philip Mantle, John Purdie of Channel Four (UK) and the secretary of David Roehring of Fox Network, USA. He is American, an old man, and lives in Florida. He was in hospital when Gary Shoefield wanted to meet him, and was coughing when Philip Mantle had him on the phone. According to his story he had polio as a child.<sup>2</sup> Polio victims at that time mostly walked with a limp. He could not have had a bad hand, otherwise he could not have worked as a cameraman, but maybe he had a bad leg. The movement of the cameraman in the film indicates this, since he doesn't move smoothly. Bob Shell enquired among senior US military cameramen if they could remember a colleague from the 1940s with a bad leg. They knew one. His name is Jack "X", and he is exactly the age claimed for the Santilli cameraman: eighty-six.<sup>3</sup>

The cameraman is *not* Jack Barnett—a name used originally by Santilli to protect the identity of the true cameraman. Jack Barnett worked for Universal News, filmed Elvis Presley at a high-school concert in 1955 and died in 1969. Jack X did not work for Universal, but filmed Elvis at another concert, an open-air one, when the Universal cam-

eramen were on strike.<sup>4</sup> The cameraman agreed to be interviewed by a major US TV network.<sup>5</sup>

In April 1996 Bob Shell was contacted by the US Air Force following an enquiry from President Clinton's scientific adviser, Dr John Gibbons. The USAF Captain told Shell that they had located footage from the same stock in their archives and verified that at least part of the Santilli material is genuine, and shows no dummy and no human. They knew the cameraman's name—Jack X—but asked Shell to forward an address, since the military records building in St Louis had had a fire and many records had been lost. A search would be time-consuming and expensive.<sup>6</sup>

When we asked for details about the crash site, we became convinced that the cameraman indeed has an excellent knowledge of the area in question. With Ray Santilli as the intermediary—and Santilli did not know anything about the area in question and insisted on calling Socorro "Sorocco"—he even described a ruined bridge that we could locate only on our third visit to the area. He knew exactly what he was talking about.

Although some have criticised the cameraman's technique in the autopsy film, other military cameramen think this is exactly the way they, too, would have filmed it.

"The cameraman keeps moving to get out of the way of the surgeon and keeps trying to get the best perspective. The job of an army cameraman is to record a procedure on film, not to deliver beautiful pictures. And that, here, is an adequate filmic protocol," said Dr Roderick Ryan, US Navy cameraman during the '40s and '50s who filmed many secret government projects including the atomic tests on Bikini Atoll.<sup>7</sup>

"Among these circumstances, no one could have made a better

job...he was not only a well-educated and experienced movie man, but, additionally, in full knowledge of editing and production of documentaries. Evidence: filming the autopsy activities from various view angles," said Col. Colman VonKeviczky, who studied at the UFA Film Academy in Berlin Babelsberg, was head of the audiovisual division of the Royal Hungarian General Staff, cameraman and director of the 3rd US Army at Heidelberg and member of the audiovisual department of the United Nations in New York.<sup>8</sup>

**The USAF Captain told Shell that they had located footage from the same stock in their archives and verified that at least part of the Santilli material is genuine, and shows no dummy and no human.**

#### THE FILM STOCK

Careful study of stills made from the original film and high-quality Betacam copies confirmed that the film was indeed shot on 16-mm material. The camera handling seen on the autopsy film indicates the use of a small, lightweight camera with fixed lenses (therefore, the out-of-focus close-ups), like the 16-mm Bell & Howell Filmo Camera used by US military cameramen in the '40s—the camera the cameraman claims he used.<sup>9</sup>

Leaders of 16 mm film were sent to Kodak Hollywood, London and Copenhagen and turned out to bear the symbols (a square and a triangle) used by Kodak either in 1947 or in 1967.<sup>10</sup>

Two segments with three frames each, one clearly showing the autopsy room, were given to Bob Shell, editor of *Shutterbug* magazine and also a phototechnical consultant for the FBI and the US courts. After a careful physical analysis, Shell confirmed the segments to be pre-1956 16-mm film. In 1956 Kodak changed its film-base from acetate-propionate to triacetate, and the samples were clearly on acetate-propionate film. The film type was Super XX-Panchromatic Safety Film, a high-speed film used for indoor filming but which had a life-span of no more than two years,

when cosmic radiation would cause a 'fogging' of the material. Shell is sure the film was exposed and developed within two years. This, at least, dates the film as pre-1958.<sup>11</sup>

#### THE EQUIPMENT & OBJECTS IN THE AUTOPSY ROOM

Everything in the film dates to the time in question. The telephone is an AT&T model from 1946,<sup>12</sup> and spiral cables had been optional since 1938 and standard for US Army telephones.<sup>13</sup> The wall clock is a model on the market since 1938,<sup>14</sup> and the microphone is a 1946 Sheer Bros mike.<sup>15</sup> The table with the instruments was standard equipment for a pathologist, as confirmed by Prof. Cyril Wecht, ex-President of the American Academy of Forensic Sciences.<sup>16</sup> The bone hammer was not unusual; nor was the Bunsen burner which, in autopsies, served the purpose of burning away body fat.



## THE BODY

The corpse on the autopsy table has been the subject of many disputes as to whether it is a dummy, a girl with a genetic disorder or, indeed, an alien. Nearly all special effects (FX) experts concluded that it is certainly possible to fake footage of a realistic-looking autopsy. There have been many concerns about 'snuff' movies and the origin of the corpses used in them. South America had been named as a possible origin, but reports from there have indicated the use of very realistic dummies. However, no one has found any evidence of special effects being used in this autopsy film—although today, unquestionably, nearly everything can be faked with the latest state-of-the-art FX techniques.<sup>17</sup>

On the other hand, pathologists and physicians from all over the world who saw the film were pretty sure the body was not a dummy, but actually a corpse—human or humanoid.

It is indisputable that some of the characteristics of different genetic disorders can be found in the being on the autopsy table—mostly disorders such as Turner's syndrome or progeria, combined with polydactylism (which is not a typical element of Turner's syndrome, although possible in combination with it) and other anomalies. This prompted a German dermatologist, Dr T. Jansen of the Policlinic of the University of Munich, to publish a study in a medical journal, trying to prove that the body is that of a girl who died from a rare form of progeria.<sup>18</sup> On the other hand, he forgot to explain why there could be two girls with identical symptoms including polydactylism, when progeria is so rare that there are only 20 cases worldwide. Unfortunately, the only case of Turner's syndrome twins, although obviously documented on film, was never published in the medical literature.

Indeed, Dr Jansen's 'findings' do not explain the extreme precautions taken when the autopsy was performed, i.e., why would the team have worn bio-hazard protection suits if the body had a genetic disorder, and why would the being have been fitted with black eye-lenses? Although Dr Jansen diagnosed a stroke (common for progeria patients) as the cause of death, this does not explain the damaged right leg, the broken and swollen left leg, the cut-off right hand and a bruise at the left temple with a possible bullet wound. Should we assume that our creature broke its legs, cut its right hand and shot a bullet in its head before it died from a stroke?

More than that, Jansen's explanation for the missing navel couldn't convince us, either. To quote Dr Jansen, "It's like if you put up an umbrella: the unevenness disappears."<sup>19</sup>

On the other hand, quite a number of pathologists concluded that the being was not human at all, since its inner organs were like nothing they had ever seen:

Prof. Christopher Milroy, Home Office Pathologist, University of Sheffield, UK:

**There was not a single physician or pathologist who, after watching the full film, concluded it was a hoax or that the being on the table was a dummy. They all agreed the corpse was of a living, biological entity—human or not.**

"Although a close-up of the brain was shown, it was again out of focus. However, the appearance was not that of a human brain."<sup>20</sup>

Prof. Mihatsch, University of Basle, Switzerland: "As for the organs removed, they could not be tallied with any human organs."<sup>21</sup>

Prof. Cyril Wecht, Ex-President, American Academy of Forensic Sciences, USA: "I can't place these structures in an abdominal context... I find it difficult to bring in any connection with the human body as I know it. The structure that must be the brain, if it were a human being, does not look like a brain...it does not seem to be a human being."<sup>22</sup>

Dr Carsten Nygren, Oslo, Norway: "This is not a human brain. It is...much too dark."<sup>23</sup>

Prof. Pierluigi Baima Bollone, University of Turin, Italy: "When we look at the inner organs of the body we find no single organ that in any way resembles any human organ. The main organ, which could be the liver, has neither the shape nor the location of a human liver. The face of the alleged extraterrestrial shows surprising anatomical features: very big ocular orbits, a very flat nasal pyramid,

a mouth somehow wide open...nevertheless, the face is flat, there is no evidence of facial musculature which is present in human beings and is responsible for the large variety of facial expressions of the human species... My overall impression is that we are dealing with a creature that seems to belong to our species but is so clearly different from us that it seems absurd to speculate about the similarity."<sup>24</sup>

There was not a single physician or pathologist who, after watching the full film, concluded it was a hoax or that the being on the table was a dummy. They all agreed the corpse was of a living, biological entity—human or not.

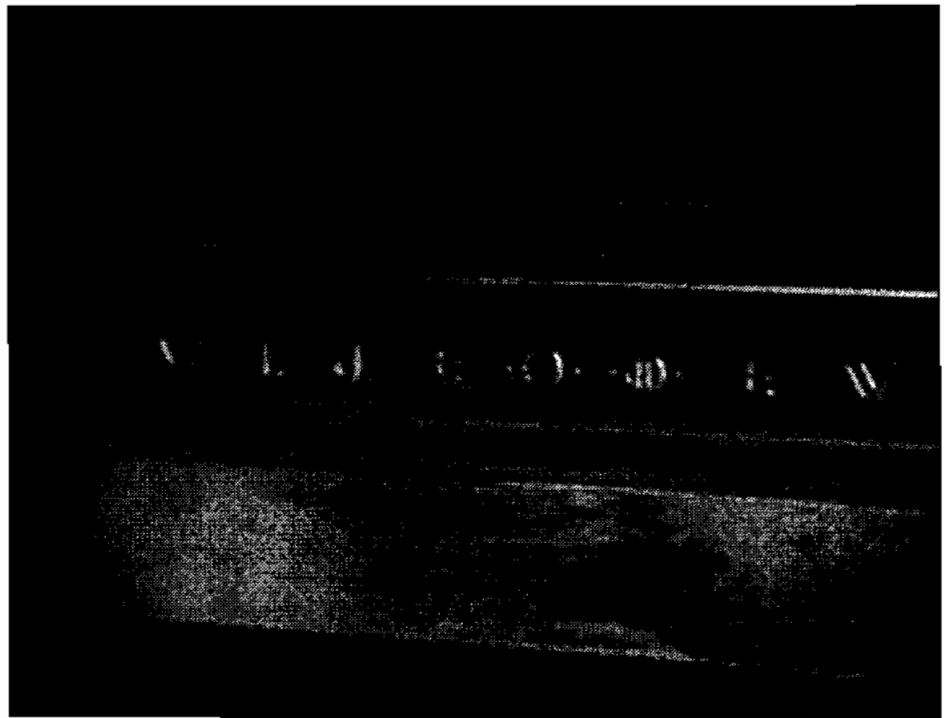

## THE PATHOLOGISTS

According to the cameraman the autopsy was performed by "Dr Bronk" and "Dr Williams".

Prof. Dr Detlev Bronk (1897-1975) was no surprise, since his name already appeared in the controversial "Majestic 12" documents. He was Chairman of the National Research Council, America's leading biophysicist and a member of the Advisory Committee of the Army, Air Force and of the Atomic Energy Commission—certainly a person to whom the supervision of an autopsy of this relevance could have been entrusted. After his death, all his papers and documents were preserved at the Rockefeller Institute for Medical Research, of which he was President from 1953.<sup>25</sup>

Dr Bronk was a very methodical person, kept detailed diaries and all his correspondence, notes and dates. But when Bob Shell wanted to look through his papers and diaries for 1947, he learnt that, mysteriously enough, this is the only year for which all the records are missing. None of the friendly librarians could tell him what had happened to them or why they are still missing.<sup>26</sup>

Dr Williams might have been Dr Robert Parvin Williams (1891-1967), who was Special Assistant to the Surgeon General of the Army at Fort Monroe, Virginia. He was a Lt. Col. in 1947 and was promoted to Brig. General in 1949.<sup>27</sup> Alone, the naming of Dr Williams—who was the right man in the right place for the task—indicates the cameraman had some inside knowledge.



**According to the cameraman, four living aliens were found at the crash site. One did not survive the recovery operation, the second and third died about four weeks later, and the fourth survived until May 1949.**

Were the protagonists of the alien autopsy footage indeed pathologists or surgeons—or just actors? We asked the physicians who viewed the footage:

Prof. Dr Ch. Milroy, University of Sheffield, UK: "Whilst the examination had features of a medically conducted examination, aspects suggest it was not conducted by an experienced pathologist, but rather by a surgeon."<sup>28</sup>

Prof. Dr M. J. Mihatsch, University of Basle, Switzerland: "I do not question the capability of the pathologist or surgeon who is working on the corpse."<sup>29</sup>

Prof. Cyril Wecht, American Academy of Forensic Sciences, USA: "(They) are either pathologists or surgeons who have performed a number of autopsies before."<sup>30</sup>

Prof. Pierluigi Baima Bollone, University of Turin, Italy: "Definitely surgeons, not pathologists...well-experienced."<sup>31</sup>

Prof. Jean Pierre, University of Paris, France: "The persons who performed the autopsy were certainly of the medical profession, if not experienced pathologists."<sup>32</sup>

Dr Carsten Nygren, Oslo, Norway: "These were surgeons

doing the work, not pathologists."<sup>33</sup>

In fact, neither Prof. Bronk nor Dr Williams were pathologists: Bronk was a biophysicist and Williams a surgeon. Indeed, not one physician concluded they were actors or made any mistakes.

One point of criticism was the type of autopsy performed. Obviously it served the purpose of determining the cause of death rather than of learning more about an alien life-form. On the other hand, this is explainable by the circumstances under which the autopsy was performed.

According to the cameraman, four living aliens were found at the crash site. One did not survive the recovery operation, the second and third died about four weeks later, and the fourth survived until May 1949.

We do not know anything about the autopsy of the first creature, and it might very well have been that it was subjected to a 'big' scientific autopsy.

The cameraman filmed the second and third autopsies on 1st and 3rd July 1947, when the main concern might have been to find out the cause of their sudden deaths in order to find a way to keep alien no. 4 alive—unless they could establish communication and find out why these visitors had come to Earth. This was surely of a higher interest for the national defence forces than a scientific study of an alien life-form. Nevertheless, we assume that organs were taken for further study during the dissection.

Furthermore, according to the cameraman, the fourth alien was autopsied scientifically in a medical theatre in Washington, DC, in the presence of leading scientists from the US, England and France.<sup>34</sup>



## THE DEBRIS FOOTAGE

The Santilli footage showing metal samples was analysed by Dennis W. Murphy, who has an Academy of Science degree in marine diving technology and welding and has studied all types of metalwork.

He concluded: "I have never seen anything that resembles the manufacturing techniques used in the construction of the I-beams in the Santilli debris footage. I know of no manufacturing process that could produce the multitude of details found on the I-beams."

Murphy refused possibilities like milling ("When I look at the lettering I see precise rounds as part of the symbols. I do not think that you can do this with current milling machines..."), extrusion, rolling, casting, moulding ("against moulding...the apparent lack of weight for all the pieces..., the acute right-angles at the roots, the thinness of the flanges of the I-beam and the finely detailed definition of the raised symbols...", which could only be produced with metal of a high density which is much heavier than the indicated weight), and the use of foam-core paperboard ("the crystalline nature of the break in the broken beams, the reflectivity of the material in the break, the rigidity of the I-beams..." argue against this possibility, according to Murphy).

The nature of fractures, the flexible, light and highly reflective appearance of the I-beams baffled Murphy and brought him to the conclusion that, indeed, metal with an extremely fine, crystalline structure had been used, manufactured with an unknown technique.<sup>35</sup> The same conclusion was drawn by Prof. Dr Malanga of the University of Pisa, Italy.<sup>36</sup>

Master Sergeant Bob Allen, USAF security coordinator at a top-secret research facility near Tonapah, Nevada, recognised the panels on the film: "The army came, after many years, to the conclusion that the beings had taken the boxes out with them because they were waiting to be picked up. Each panel was constructed for each of the ETs individually. They could be fitted into slots in various apparatus. The entire system—propulsion, navigation, everything—could be started and controlled by these panels. We tried it too, but our brain frequency was not fast enough to operate them." According to Allen, they were presented, together with other "alien hardware", every 10 years to the Lawrence Livermore Laboratories for examination as the basis of latest state-of-the-art science.<sup>37</sup>

This was confirmed by a USAF engineer, working for Sandia Laboratories in Albuquerque, who identified them as some kind of "biofeedback computers responding to neural impulses".<sup>38</sup> "We learned how to feed information into them, but we were not able to get information out of them," he added.

Bill Uhouse, a mechanical design engineer who worked at the top-secret facility at Area 51 on the Nevada test site—where he allegedly worked with alien technology—identified them as "personal control panels. They served to communicate with the individual member of the crew and possibly to interact with a computer on board or, better, the steering unit. When the craft crashed, each crew member took his panel with him. Possibly they served as communication with a mother ship, which could locate and rescue them."<sup>39</sup>

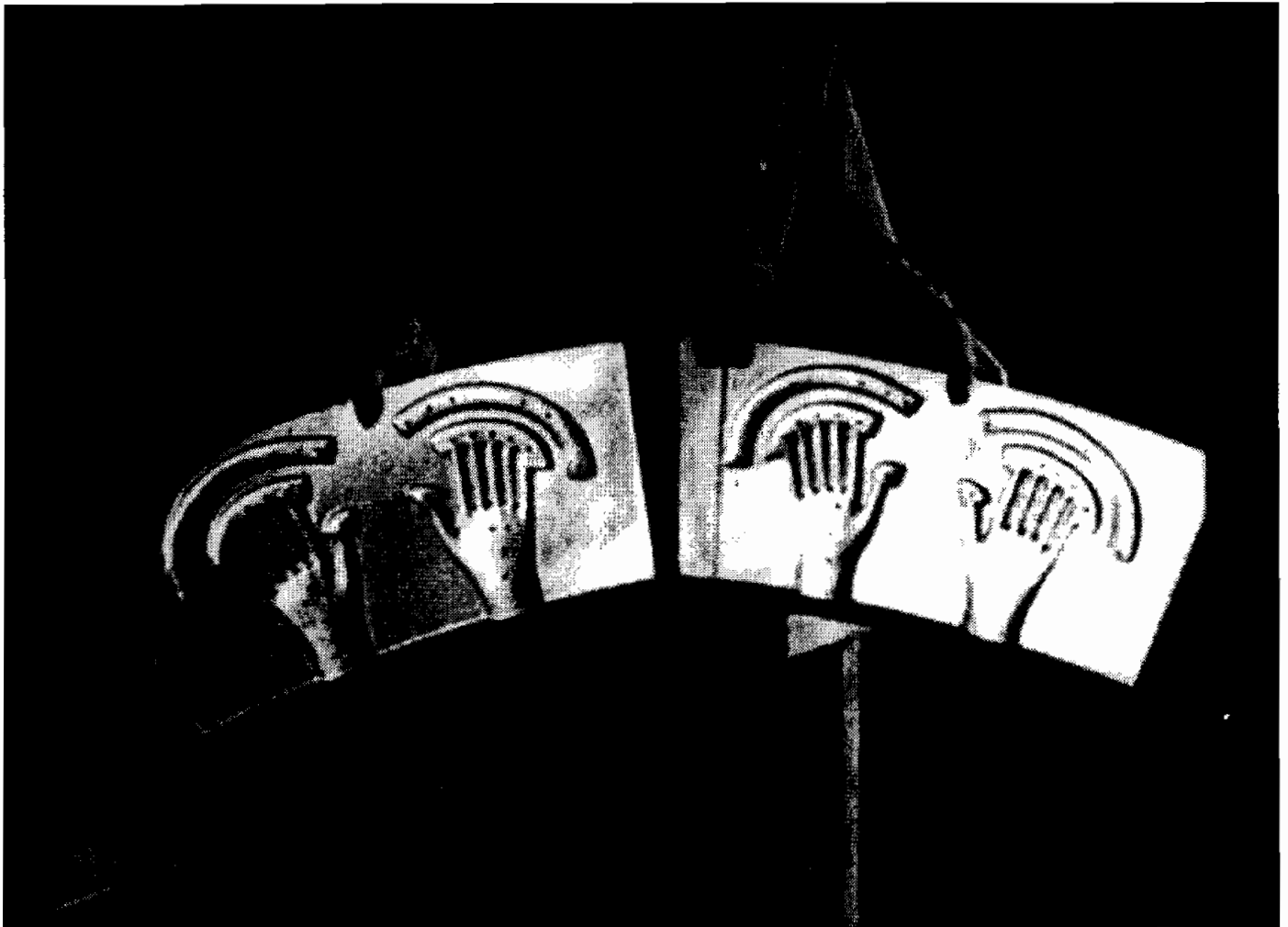

## THE HIEROGLYPHS

When I first saw the hieroglyphs on the I-beams, I immediately recognised a similarity with the Greek and Phoenician alphabets. Indeed, both of them have a common origin and belong to the same 'family' as the many different Semitic alphabets—Aramaic, Sabaic, Samaritan, Hebrew, Protocanaanitic, Nabataic and Arabic—which all originate from the hieroglyphic alphabet, one of the four main groups of Egyptian hieroglyphs (the others being two- and three-syllable signs and ideograms).<sup>40</sup>

Interestingly enough, inscriptions which clearly belong to the same family of alphabets, but pre-date the Phoenician or even the Egyptian culture, have been found all over the world—in Peru (Ylo),<sup>41</sup> Ecuador (Cuenca),<sup>42</sup> Brazil (Piedra Pintada),<sup>43</sup> France (Glozel, Maz d'Azil),<sup>44</sup> on the Canary Islands,<sup>45</sup> and elsewhere. Because of their similarity with the Phoenician alphabet, I call them "Proto-Phoenician".

In this context I was able to decipher both I-beams and translate their inscriptions using languages from the same context and language families as the alphabets. They say: "DIREQH ELE/ECE" and "OSNI". "DIREQH" is related to the Hebrew "Derekh", meaning "way, path, journey". "ELE" could be a plural of "El", meaning "God", like the Hebrew "Elohim", and "ECE" is related to the Egyptian "ase", meaning "to introduce" or "to approach". So, depending on whether we read the second sign as a "lambda/lamed" or a "gamma/gimel", we can translate it alternatively (since we don't know the grammar) as "the journey of the gods", a prayer, like "Go with God", or "a journey to approach/introduce". I translate "OSNI" as the Egyptian "asni", meaning "to make to open",<sup>46</sup> either philosophically, as in "to open for a contact" or "to open the consciousness", or, in a practical sense, as in "Open here".

But why would extraterrestrials speak and write like Phoenician, Hebrew or Egyptian? Maybe because it's the language of the gods, who introduced it on Earth. In fact, the ancient Egyptians believed their hieroglyphic system had been brought to them by Thoth or Tehuti, the God of Wisdom, one of the Neteru ("Watchers") who travelled in the celestial barks on the celestial Nile—the Milky Way.<sup>47</sup>

Is it a coincidence that the mathematical system of both ancient Sumer and Egypt was based on 12, when here we meet beings with 12 fingers? We find twelve-toed footprints on Anasazi petroglyphs in the Canyonlands of Utah, USA,<sup>48</sup> and a twelve-fingered Sky Kachina in the tradition of the Laguna, Hopi and other Pueblo Indians.<sup>49</sup> The Brazilian Ugha Mongulala believe their "Ancient Fathers", who came from the stars, had "six fingers and six toes as signs of their divine origin".<sup>50</sup>

## ROSWELL OR SOCORRO?

Ray Santilli's claim that the film was "the Roswell footage" caused a lot of controversy, since none of the witnesses to the July 1947 UFO crash/retrieval event had confirmed either the bodies or the debris. Indeed, the corpses found in Roswell were smaller, more slender, and had four or five fingers, according to eyewitnesses.<sup>51</sup> None ever mentioned six fingers. In any case, if the film were a fake, why did those responsible for it not care to read at least one of the many books on this subject or see the excellent TV mini-series, *Roswell*, by Paul Davies, as shown on *Showtime*?

The very first information I got from Santilli about the source of the film made me wonder if it actually had anything to do with Roswell at all. Ray already insisted on 5th May 1995 that the autopsies had been filmed on 1st and 2nd July 1947, and that the recovery had taken place "in the beginning of June"—one month too early for Roswell.

When I went to Roswell on 30th June 1995 to confront the eye-witnesses (including Robert Shirkey, Glenn Dennis and Frank Kaufmann) with the just-released stills from the film, I asked Santilli for details about the crash site. He could only tell me it was "about four-and-a-half hours away", "close to White Sands test site" and "an Apache reservation", and "at the northern shore of a small dry lake at the end of a small canyon". I asked him to call the cameraman to obtain more detailed instructions, which, indeed, he did. He said the crash site was "between Socorro" (Ray said "Sorocco") "and Magdalena".

By the end of July 1995, Santilli released the full story of the cameraman who confirmed he had learnt of the crash on 1st June 1947—which dates the event back to the late hours of 31st May 1947. Date, location and everything we see on the film didn't fit with Roswell. Conclusion: it was a different event.

The fact that the cameraman had been flown into Roswell and brought to the crash site by car, caused him to believe he'd been involved in "the Roswell incident" that he'd heard about—and Santilli believed him.

**Date, location and everything we see on the film didn't fit with Roswell.**  
**Conclusion: it was a different event.**

## THE CRASH/RETRIEVAL SITE

Following the instructions given by the cameraman, I was able to find the small dry lake at the end of a canyon by following "the last dirt road before the (Magdalena) mountains". It was about 15 miles away from the White Sands Proving Grounds and the Bosque del Apache National Wildlife Resort, a former reservation.

On the third visit to the site, Ted Loman was even able to find the ruins of a (railway) bridge mentioned by the cameraman. After we sent photographs to the cameraman, he was able to confirm the site.

In September 1995 Santilli released the cameraman's drawings, enhanced by a graphic artist, showing the crash scene. Although the scenery in our photographs looked different, we found that, coming from the canyon, it looked exactly like it was in his drawings. Right where he drew the craft crashed into a cliff, we found an area, 20 metres in diameter, where someone had deliberately sizzled off the rock as if trying to remove traces.

Above the dry lake bed we located an old mine. According to the New Mexico Office of Mining & Technology in Socorro it was a manganese mine, called "Niggerhead Mine", which was closed in 1938, reopened during the war when manganese was precious and needed, and closed down again in 1945. According to the cameraman, it was again reopened by the US Government (Department of the Interior), but with no further mining, on the very day the retrieval began: 1st June 1947.<sup>52</sup> Mining operations were used as cover events for the *Manhattan* Project and maybe also here. Isn't the reopening of a mine a perfect excuse for moving in heavy equipment—cranes, flatbed trucks—and personnel, and cordoning off of an area?

Continued on page 90





# An Extraterrestrial Perspective on Earth

*According to Collier, the Andromedans remind us that unless we can learn to live responsibly in peace and love, the human race will become extinct.*

## Part 3

### A Lecture by Alex Collier

Extracted from  
**The Leading Edge**  
(Issue No. 89)  
Leading Edge Research Group  
PO Box 7530  
Yelm, Washington 98597, USA

**A**lthough many elements contained within this December 1995 lecture by ET contactee Alex Collier are unverifiable, this material is so highly interesting that it demands presentation. Relate it to other material and decide for yourself. Together with other information in existence, it appears to have a bearing on the immediate future of planet Earth and all its inhabitants.

(Note: AC = Alex Collier; Q = Audience questioner)

### Vibrational Changes and Self-Responsibility

**AC:** We are being told that there are too many people on the planet. According to the Andromedans, if we didn't waste our natural resources, the planet could hold a population of 11 billion. Now, a planet with 11 billion spiritually-awakened people cannot be controlled. Such a scenario would change the harmonic frequency of the planet, the solar system and the galaxy. That vibration would be love, and the bad guys don't like that. It all starts here.

We are being told that there are too many people. It's a lie. Our leaders are so corrupt that the systems they have are breaking down. Instead of acting responsibly, releasing control and letting people take more self-responsibility, the corrupt leaders in the world want to kill off most of the population in an attempt to maintain the status quo.

So, who is the real power here? Us! Few people want to stand up and 'claim their space'. Why? Because in order to do so, you have to be self-responsible. That means you have to learn to depend on yourself, clothe yourself, feed yourself, do something for yourself. We have to make some fundamental changes. We will have a solution if we put our heads together. If anyone says, "I am here to save you and I have all the answers!", you had better turn your back and walk the other way.

**Q:** What about the beings from the Sirius B system?

**AC:** Some of them are human, and they have eyes like cats. Their skin is grey. They have long, straight red hair. Many of them wear full body garments that cover their heads. They have extremely bad breath.

**Q:** Do they mate with humans?

**AC:** Yes, but the eggs need to be altered in a lab. They are using us. They want the encoded information in our genes. We have racial memories and abilities in our physical bodies. We are moving from third to fifth density. It is the first time it has ever been done, and we can do this because on a soul level we are the Paa Tal. We have the genetic coding of 22 different races in our bodies. When our DNA starts to unlock, we will be able to speak to ETs in their own tongue. We cannot be lied to any more. We will be able to create and manifest anything. That takes some responsibility.

Those who are stuck on manipulation and control will manifest exactly what they desire. This means that there is a very heavy responsibility when it comes to what is behind your intent to create. If you screw up, it's going to hit you almost immediately.

### Our Solar System at Fifth Density

The Andromedans say we have 13 planets in this solar system. When we move into fifth density, it will become apparent that there are 27 planets in our solar system. They are already here but on another dimensional frequency, which is why we don't see them at present. When we get to fifth density, it will be evident that Jupiter is a sun, which means at that level we will have a binary star system. Jupiter, in fifth density, is light blue.

I am told that in 1,000 years, the fifth density future generations of us that will incarnate on the fifth density physical dimension will have light blue skin because of this sun.

## The Space of Fear

My understanding is that as you move into a space of fear, you are automatically a victim; you put yourself at a disadvantage, and you literally draw that experience to you, because those that are trying to suppress you will want to feed off the energy. The only reason that fear exists is because we allow that idea to feed off us.

Morenae said this to me in 1991: "In your time and space, the expression of fear will be a challenge to you all. For any of you to be in fear, you lack a clear understanding of most situations. We have observed that your world is at a most confused point in your history and evolution."

Now, folks, some of these lines may not make sense, but it was exactly the way Morenae said it. He and Vissaeus don't know English very well, but they are doing the best they can to express themselves.

Morenae continued to explain: "We understand your remarkable drive and commitment to being alive. We, however, are not understanding of your need to create tools of death, expecting they will keep all in a space of understanding and peace. We have observed that you build, create and plan in a space of fear, not in a consciousness of love. So, your defence position of institutions that create and employ is always in a state of unravelling and disintegration. We share this with you because they drain you and your Earth of energy, both spiritually and materially, physically."

"Fear always has to feed. Fear does not create itself. It has to feed. The fear we observe is difficult to understand. It depletes you of your focus on the original intent. It is a very secretive energy. Fear withholds love. This is most saddening to see and feel. How can you share understanding and love when so many of you are withholding from Self and each other? Please, feel the words that we as a race are trying to express to your race."

"One of your original intentions in creating your physical reality is the idea of creating and learning to manipulate and express yourselves through physicality using your consciousness. It is your consciousness that the Is-ness has given you, and in fact all things that bear Spirit. It is this gift that has been clouded and, most importantly, clouded by fear. This creation is completely irrational to who we all are. We have come to understand that withholding love only creates perpetual disintegration."

"We have discovered in our home galaxy the ruins of vast races that were achieving recognition but which have ceased to exist. They destroyed themselves simply because they withheld love. They drained the very life-force out of their intent, and imploded and destroyed their self-creation."

"The first projection of fear is denial—an emotion of incredible restriction. Denial and fear result in the complete opposite of the reality it claims to be. Fear is based, from our perspective, on a misunderstanding of one's own worth and security. Why is this so? We have discussed your race amongst ourselves in Andromeda and we have formed a perspective based on your history."

"Many of your religions have both helped and hurt this process. Some of your world's beliefs have convinced many that they are sinful creatures of Nature. Your science teaches that your physical form is a pool of chemicals thrown together by accident, so that you are all an accident, living meaningless lives of chance."

You fear a God whom a book says is a loving God who will throw you into an abyss for eternity for making a mistake. Many in your world have come to understand that fear—the idea of fear—is their enemy. All of you struggle between understanding and fear, and reason and fear. This struggle is in no way predetermined. Our perception is that this struggle will lead your world to peace and responsibility—or to extinction as a race. This would grieve us. It is time to return as One."

It is really interesting to hear the perspective of how other races view us. If you have been in situations where you detach yourself emotionally, you have a completely different perspective of the situation.

## Reincarnated Souls and "Walk-ins"

From what the Andromedans have told me, there are both positive- and negative-reincarnated souls here on Earth. The souls of the individuals Washington, Jefferson, Lincoln, Franklin and Napoleon are back. Three of them have come in with full consciousness and know who they are. I don't know which three. The souls that inhabit the physical bodies of the global banking families are Maldekians, and they know who they are.

This is what Morenae has told me about walk-ins, negative and positive. There are many people on the planet who are world leaders but are not who they appear to be. If you have a gut

instinct about some of these people—which may be hard for the men to express but easier for the women—please honour it.

What the negatives do—and they can do this during an abduction or near-death experience—is the following. During an abduction, a man, for instance, will be taken aboard a ship. His body will be brought into a coma and to the point of death, whereupon the soul exits. They will then use technology to replace the original soul with another soul, and then return the individual's body. They can do this

process in four seconds. The new individual has a completely new agenda. If you are a negatively oriented ET, in order to manipulate third density you have to be in third density. This is how they are doing it. Some choose to be in human form. This is Orion technology, and the regressives need technology to create what humans can do using consciousness alone. That's the fundamental difference.

With the positively oriented ETs there is an agreement with the soul wherein one soul will exchange with another to come here and do good works. The positives are using this extensively right now. There are thousands and thousands of what you call "walk-ins" on this planet. Because they cannot intervene, they have to come in physical form and participate in the process in a human body. Morenae has told me that real walk-ins will not tell you they are walk-ins. They will not, so I don't know who these people are who are saying this. This is their perspective.

## The Second Coming and Related Topics

This is a touchy subject, and I have mixed emotions about this. If the Andromedan perspective about many of our religious teachings is true, then we are being set up.

The Greys have the ability to create a clone—something that looks like a human being but is a robot. My understanding is that the only way you can tell between one of these clones and a real

**"We understand your remarkable drive and commitment to being alive. We, however, are not understanding of your need to create tools of death, expecting they will keep all in a space of understanding and peace."**

human being is if you are clairvoyant and can see the energy field. A clone has no energy field around its body—only a slight white colour around the head, which is the field produced by the micro-processor that has been grown inside the head.

If they do this, i.e., set up a Second Coming, a man will probably be brought out of the clouds, probably on a UFO, and he will look like the man on the Shroud of Turin—which, I have been told by Morenae, was created by the Greys by going back in time and projecting a hologram through it, which is why this image is three-dimensional.

Now, a hologram is real; *we* are a hologram. I know how far out this sounds, but let's face it: the regressives are not 'playing with a full deck' here. We already know that, and there are a lot of people who will do anything to protect themselves because they are oriented towards service to self. I want to tell you that I personally hope this is not true. I don't want it to be true. But if it is, I have a responsibility to share it. So, I am putting this out there and will let you decide.

This being is not the Anti-Christ, who is supposedly another clone. See, they are going to play this thing out because two-thirds of the planet believe it already. They're saying, "Well, let's just fulfill it for them; that will solve their population problem because they'll kill each other. We'll just sit on the Moon and watch this happen." It's really simple if you put yourself in their place. They're saying, "Give humans enough rope and they will hang themselves." We have been fighting about religions forever. I mean, we all agree that we're talking about the same God, but we all still play this game.

Now, this being is supposed to come down and start preaching many of the Hindu philosophies. It will be this clone who is going to ask everybody to surrender their free will. Now, if we can shift planetary consciousness as quickly as possible to a place of love, they will not be able to pull this off. If the Lord is real, maybe he'll get here a lot quicker. See, folks, I just don't know. I just don't know. This is one of the issues where I am confused.

The Andromedan perspective of the Bible is that it is simply literature with historical accounts in it. They say that Constantine was so busy burning the resources of the Roman Empire and stopping religious wars that he decided to create a State religion. He took the religions of the West, which worshipped Isis, and the religions of the East, which worshipped Krishna, and put them together. Isis-Kristos. I don't know about this, because I wasn't there.

I don't want to do the wrong thing, so now I have to question everything. I don't question my relationship to God—I am crystal-clear about that—but I do question the idea that I am not responsible enough to take care of myself. I don't want to put my faith in somebody else when it is not supposed to be there. I want to get this thing right, just like everybody else does. I want to live in peace. I want to live in abundance. I want to raise a family, just like everybody else does. So, I put this information in your care. You do what you want with it.

I am sharing with you what I know and don't know. Look for something really bizarre happening between 31st December 1999 and 1st January 2000 when all the world leaders are due to meet at the Great Pyramid of Giza in Egypt. Count on something really

bizarre happening at that time. We will probably know of ETs and have information from ETs long before then. We may not meet any of them until then, but the next four or five years are critical. They are going to be implementing their plan of domination of free will and self-expression.

### Nazi Scientists and Time-Travelling Greys

When the Greys got here they were the front team for the Orion group. They literally could not pierce the membrane we had around our third density creation until 1931. We were not detonating nuclear weapons then, so I asked Morenae what happened.

Apparently some German Nazi scientists were experimenting with time travel and they opened a 'door'. They put a 'crack' in time, and there was a bunch of regressives right there, waiting. I don't know how they knew, but they were right there. So, they came here, into our reality, in 1931. Once they were here, they were able to skip back into time. In our history books the Sumerians, Babylonians and Egyptians talk about "the gods". They were ETs that came into our reality in 1931 and went back and started manipulating mankind!

### The Paa Tal

I don't know a lot about the Paa Tal, except that the Andromedans say that *we* are the Paa Tal, who came back down from the 11th density to play this in third density, and that this movement involved 21 other star systems. Our own galaxy here is apparently close to the centre of our 'consciousness universe', as it were. This is why we all seem to be 'lumped together' here. We apparently fell into the concept of time prior to 21 billion years ago, when third density physicality did not exist. The Paa Tal created third density in order to play this game. I don't know whose idea this was, but next time you can count me out! This is what they say, and I have no way of

**So this is why so many different races are talking to people, people are channelling entities, and they are all basically giving us the same message: "This is your idea, and we need you to wake up!"**

verifying this.

When this third density Universe was first created, we were at fifth density, after having evolved to 11th density. This means we had within us experiences accredited to all these dimensions. We are told that everything is connected in some way. Well, if we evolved from fifth density to 11th and then came back down to third, everything we do here affects everything, all the way up and down. But, because this reality was our idea, our creation, the positives have a hard time figuring out how to help us because *we* set up the ideas involving free will and self-expression. They don't want to come in and make the problem worse, because if they do it will end up affecting them and it will then be their 'fault' as well.

So this is why so many different races are talking to people, people are channelling entities, and they are all basically giving us the same message: "This is your idea, and we need you to wake up!" They cannot help unless they are asked, because then they would be intervening and equal to the regressives that are repressing us. It's a tough situation, and I think God has made a decision about all of this, and I thank God for that. Because now there is a 12th density which is forming, higher than the 11th, and this process is pulling everything up in density.

If the Andromedans are right, then God has made the decision to change the game. We are all coming home. It is as if God

were saying, "I've let you play long enough. You're stuck. I love you, so I'm going to fix the situation." This is great, because we only have 40 years of oxygen left on this planet at this density. So, we have played our game right to the end. We took it as far as we could take it without self-destructing. We are all responsible for this, and we are all going have to stand together.

### Our Ancient Heritage

I want to talk to you about Lyrae and how the human race colonised our galaxy. Based on the age of the suns and the planets in our galaxy, it was decided that the human life-form was to be created in the Lyran system. The human race lived there, evolving, for approximately 40 million years. The orientation of the human race in Lyrae was agricultural in nature. We were very plentiful and abundant, and lived in peace.

Then, one day, huge craft appeared in the sky. A large ship came out of the huge craft and approached the planet Bila. Reptilians from Alpha Draconis disembarked. Apparently, the Alpha Draconians and the Lyrans were afraid of each other. I told you before that the Alpha Draconians were apparently the first race in our galaxy to have interstellar space travel and have had this capability for four billion years. Well, when the Draconians saw Bila, with all its abundance, food and natural resources, they wanted to control it.

There was reputedly a miscommunication or misunderstanding between the Draconians and Lyran humans. The Lyrans wanted to know more about the Draconians before some kind of 'assistance' was offered. The Draconians mistook the communication as a refusal, and subsequently destroyed three out of 14 planets in the Lyran system. The Lyrans were basically defenceless. The planets Bila, Teka and Merck were destroyed. Over 50 million Lyran humans were killed.

It is at this point in history that the Draconians began to look at humans as a food source. This is how old the struggle is between the reptilian and human races. Now, I must make the point that not all the reptilian or human races are 'dark'. There is a mix. When we start meeting these races, you are going to have to trust your gut instinct. But, they are coming. Hale-Bopp is on its way here, and it is not a comet.

### The Draconians

The Draconians are the force behind the repression of human populations everywhere in this galaxy, instilling fear-based belief systems and restrictive hierarchies.

I asked Morenae about them, and he said, "The Draconian race is probably the most understood race of beings. I have witnessed a deep respect for this race." The Andromedans consider the Draconians the 'ultimate warriors' in a negative sense.

Morenae continued: "The Draconians are the oldest reptilian race in our Universe. Their forefathers came to our Universe from another separate universe or reality system. When this occurred, no one really knows. The Draconians themselves are not really clear on when they got here. The Draconians teach their masses that they were here in this Universe first, before humans, and as such they are heirs to the Universe and should be considered royalty. They find disgust in the fact that humans do not recognise this as a truth. They have conquered many star sys-

tems and have genetically altered many of the life-forms they have encountered.

"The area of the galaxy most densely populated with Draconian sub-races is in the Orion system, which is a huge system, and systems in Rigel and Capella. The mindset or consciousness of the majority of races in these systems is service to self, and, as such, they are always invading, subverting and manipulating less-advanced races and using their technology for control and domination. This is a very old and ancient war, and the peace that does not exist is always being tested by these beings who believe that fear rules and love is weak. They believe that those they perceive to be less fortunate in comparison to them are meant to be slaves. This belief system is promoted at birth in the reptilian races, wherein the mother, after giving birth, will abandon the offspring to fend for themselves. If they survive, they are cared for by a warrior class that uses these children for games of combat and amusement."

So you can see that the reptilians are forever stuck in survival mode. This means they have no boundaries in what they will do to other beings.

Morenae said, "It is ingrained in them never to trust a human. They are taught the Draconian version of the history of the Great Galactic War, which teaches that humans are at fault for invading the Universe, and that humans selfishly wanted the Draconian

society to starve and struggle for the basic materials that would allow them to exist."

Now, there are some real similarities there. The expression, "Draconian thought", is an expression on our world. I would suggest you research that.

### On the Subject of Intent

I would like to share something with you that Vissaeus had to say on the subject of intention.

Vissaeus said, "The smallest piece of physicality that all of you and we build upon is what your science calls the atom. You are taught that each single piece of physicality contains electrons, protons and neutrons which attach themselves together to form what you call Nature. Molecules manifest this union to create everything. We would like to expose a flaw in your sciences. Your experts teach that atoms spin unpredictably. Where is the predictable solidity of matter? Where do the elements come from? Your science cannot answer this. They have only theory. Your science presupposes that matter has its source within matter. This is the flaw we want to share with you.

"The true source of all elements of physical matter is *intent*. The intent of the *Is-ness* that makes all things possible has an invisible side, or world, that your sciences are only now begrudgingly looking at for answers. We are pleased to share with you the idea that intent is the primal force of creation. It is the *Is-ness*, whose intent and desire it is to explore and expand Itself in all possible openness, that creates all physical matter on all dimensions. It is this which has made it possible for us, as well, to explore our Selves to completion. Therefore, know this: the first material in creation is the electron. It is the 'tool' to build upon in the creation of physical reality.

"Now, let's look at you, the human. Look at yourself in the mir-

**"The true source of all elements of physical matter is *intent*..."**  
**"We are pleased to share with you the idea that intent is the primal force of creation."**

Continued on page 94







### CROP CIRCLE CREATION CAPTURED ON VIDEOTAPE

*The following is a statement issued by Colin Andrews, well-known crop circle researcher, lecturer and author:*

A man was camping out on the hilltop of Oliver's Castle overlooking the Devizes area of Wiltshire, England. The night was a very wet one, and he was on the hill, with the intention of watching the fields below for the construction of crop circles which have been found there in recent years.

At approximately 0500 hours on 11th August, as the first light appeared, he saw what he thought was a small, white-lighted sphere pass swiftly across the field directly below him. He moved quickly for his video camera, which failed to work due to the moisture sensor operating inside it. Some moments later he tried again and it started to film [videotape].

Just seconds into the film, two white spheres moved into the frame from the right and arced across the field in a large spiral, much like the form which appeared as a crop pattern at Stonehenge in June. As the spheres spiralled across the field, a small circle suddenly flattened to the ground, and, within just seconds (as many eyewitnesses have reported previously), a large, complex, crop pattern materialised.

Before the whole sequence was over, a second pair of white-glowing spheres approached from the top left of the frame. One of them appeared to lift out of the

cereal field and join its partner. They also took a route arcing around in a large ring. As they did so, the pathways and smaller circles in this elaborate 'snowflake' pattern were formed.

The whole filmed sequence is just a few seconds long, and shows either a very elaborate attempt to defraud—or we have secured the most incredibly important UFO and crop circle film footage ever.

I have been asked by the cameraman/witness to execute a detailed analysis of the film and to handle world media interest in the footage which he owns. To date, several major enquiries have commenced, including one with the British military who might have been present at the time.

The film will not be made available publicly until analysis is complete. The first results and full detailed statement regarding the footage will be made through the *CPRI Newsletter*. Many researchers and interested public are located in England, and the main CPRI offices are in the USA, therefore it is also my intention to send updates to the magazine, *UFO Reality* (available in the UK and USA), and the new crop circle information room in the Red Lion pub at Avebury, Wiltshire.

There have been several other important discoveries during the 1996 research project in the UK, and these will also be covered in the next *CPRI Newsletter*.

Please do not attempt to make personal telephone calls to CPRI offices regarding

the new footage, as, already, the international interest is immense. Priority is to be given to the film analysis, and completion of my next book, *The Signs Have Arrived*. For those who have been anxiously awaiting the book, you will glad to know that I have secured a publisher.

*(Source: Colin Andrews, Circles Phenomenon Research International, PO Box 3378, Branford, Connecticut 06405, USA; 20 August 1996)*

### THE UNIVERSE, ACCORDING TO FRED HOYLE

*Speaking at a 1971 news conference in London, controversial astronomer Fred Hoyle (Diseases from Space) had this to say about life, universes and everything:*

Human beings are simply pawns in a great game being played by alien minds which control mankind's every move. These alien minds come from another universe, one with five dimensions. Their laws of chemistry and physics are completely different from ours. They have learned to shatter the time barriers that restrict us.

These super-intelligent entities are so different from us that to comprehend them or describe them in human terms is literally impossible. These entities seem to be totally free from any such physical restrictions as bodies, and they are more like pure intelligence; we know that some of them are like that.

They are not all the same, but some of them seem to have the ability to be anywhere in the Universe in a matter of seconds. The Universe as we understand it, with all of our so-called limitations and all of this garbage about the limits on the speed of light, simply does not exist.

These aliens are everywhere; they are in the sky, in the sea and on the Earth. They have been here for countless aeons, and they have probably controlled the evolution of *Homo sapiens*. All that man has built and become was accomplished because of the tinkering of these intelligent forces.

(Source: Sir Fred Hoyle, news conference, London, UK, 10 May 1971)

## AN UNDERGROUND UFO BASE IN CANADA?

In 1961, amateur spelunkers Arnold White, Rick Grayton and Don Lawrence came across what they thought was an underground UFO base while exploring one of the many old iron mine-shafts located in Newfoundland, Canada. Arnold takes up the story:

Although now generally known, one of these mines—one of the deepest, by the way—had caused much concern and controversy among the local populace. Shortly after it had been dug to its maximum depth, strange things began to happen. Miners working late at night, in small groups of six to 10, began hearing noises: not rumbling or any other natural mine noises, but what some described as "strange music". It seemed to come from all around them, sometimes faint and sometimes distant. Later, some said they heard "mumbling" and "voices". This went on for several months, but only the miners who had heard the noises were disturbed or concerned.

Then, more serious things began to happen. One of the men entered the mine late at night to check on some equipment, and when he finished and started to leave, some "small men" grabbed him from behind, knocked his lamp from his hands and "shot" him with something that forced him violently against the mine wall, knocking him unconscious. In the morning, workers found him apparently none the worse for his experience physically, but quite shaken mentally. He said he would never again enter the mine, and promptly dropped out of the occupation.

A few days later, a miner on night watch disappeared. Investigators found his lamp and hat deep within the mine, but no trace of the miner. Soon, lights and

machinery began to fail or to work erratically for no apparent reason. Men became hesitant to work the mine. Finally, it was 'condemned' and shut down.

This was the mine in which our Canadian friend was interested and wanted us to help investigate. Although spelunking is usually confined to exploration of naturally formed caves, our curiosity was great enough to spur us on to such an unusual form of research.

We arrived in the mining town, which was near the Newfoundland-Quebec border, at 11.30 am on 22nd March 1961, and lodged at the local hotel. The next day, we got our equipment together; loaded up our Jeep and headed for the mine.

At the entrance, we were stopped by two policemen who warned us not to go inside. When we persisted, they threatened to arrest us. So we left, resolving to return on foot after dark.

At 1.30 am we set out again for the mine. This time we bypassed the police and approached the mine from a different direction. We met no interference along the way and shortly arrived at the entrance.

While Rick Grayton (my American friend) stayed at the entrance as lookout, Don Lawrence (our Canadian friend) and I descended into the mine. It was in excellent shape and showed no signs of any deterioration whatsoever—hardly the type of mine the government would condemn on its physical state alone.

We had just completed our preliminary investigation when we heard someone, apparently deep within the mine, shout in a high-pitched voice, "Come!"

We stopped dead in our tracks, and then walked in the general direction from where the voice seemed to originate. Then we heard somebody or something running.

We lit a flare, but saw nothing. We continued, and again we heard the running. By this time we were getting far back into the mine, and we were very curious and excited.

The running sounds ceased abruptly, and we saw a faint, blue light radiating from a far recess. Then we heard what we thought was the clank of a metal door closing.

We quickly found the area from which we saw the light radiating, but could find no door opening. However, upon tapping the walls with my pickhammer, we heard hollow, metallic reports at several places.

After we had localised the hollow-sounding area, we marked it off by chiselling off pieces of rock. We found that it was generally rectangular in shape, almost five feet in height and about two feet wide. Since we could investigate no further with the equipment at hand, we decided to come back the following night and continue our investigation.

Returning the following night, all three of us entered the mine. Very much to our surprise, the chisel marks were gone! It took us several minutes to find the hollow area again, but we finally did—and this time we had come prepared. Using a battery-powered rock drill, we penetrated about three inches into the rock when we struck metal. We withdrew it and substituted a bit designed to drill into metal. Eventually we breached the metal and, withdrawing the drill, we again saw the soft, blue light shining as before.

Suddenly, we heard a low, humming noise and were startled to see the section of the wall we were working on, abruptly lift out of sight. It would be an understatement to say we were frightened. What lay before us was incomprehensible: a blue-lit corridor which appeared to be made of some



Seminille

sort of translucent, seamless, self-illuminating, blue-coloured metal or plastic. As first we were very apprehensive about investigating the enigmatic hallway. Our curiosity soon overcame our fear, however, and we entered the corridor.

We had to stoop, for the hallway was only five feet in height. After walking about 50 yards, we came to another corridor leading off to our left and decided to explore it. We reached the end of the corridor after walking about a hundred yards. There we encountered a steep, spiralling stairway. We descended it for at least 20 minutes, all the while noting that the lighting was becoming more brilliant. Finally we reached the bottom and were confronted with yet another corridor. This one was light green in colour.

After a brief rest we set off down that corridor. It was only about 100 feet long, and we traversed it quickly. To the right and left were oval entrances. Making a quick decision, we decided to enter the one on the right, and noticed immediately that it was cylindrically-shaped and much larger than the previous passageways. It contained a floor on the same level as the previous ones. We also noted that this passage was evidently made of some crystalline substance and that a bright, but soft, white light emanated from it. It curved downward at a slight angle.

We came next to a huge chamber which appeared to be some type of scientific laboratory and hydroponic garden. In one section were rows of giant exotic plants and,

in another, some type of chemistry equipment. Lining the walls of this laboratory were arrays of multi-sized TV screens, dials, gauges and other electronic equipment. Some of the screens were at least 10 feet square. In the centre section was a great mass of scintillating, varicoloured crystal; it had a rough, natural exterior and apparently performed some function, though unknown. The rest of the chamber contained many other strange devices and apparatus that none of us could identify. The entire ceiling was one great light.

At the far end of the chamber stood something that looked like a car lift, with a disc-shaped metal object resting on it. We decided to take a closer look at it. Fortunately, the lift was only about two feet off the floor and we were able to get a good look at the object. It was circular in shape, about 35 feet in diameter and four feet in thickness. Suddenly, Don exclaimed, "It's a flying saucer!" We both agreed: we had indeed found a "UFO".

Rick stepped up on the lift to take a more detailed look at the saucer. He tapped on it lightly with his hammer, and parts of it sounded hollow. Immediately after he tapped on one certain spot, an entire section of its tail dematerialised. This took Rick totally by surprise and he almost fell off the lift platform. About one-half of the inner mechanism was revealed to us, and again we could not find a single piece of equipment with which we were familiar. The only thing we could surmise was that the object was a remotely-controlled device, since there was no space provided for passengers that we could see. Rick jumped down from the lift and we continued our investigation of the laboratory.

Abruptly, the lift was activated and began to drop to the floor, and at the same time the lighting in the chamber changed from a soft white to a deep red. In short order, the screen directly above and to the right of us flashed on. Due to the unnatural lighting, we could not make out the image on the screen.

Then we heard a voice from the screen. It said,

in a high-pitched voice: "You have been expected. You have been observed since first you entered our domain. You gaze upon the upper regions of our world. You are the first of your kind to be permitted this privilege. Let it be known this truth: we harbour you no ill will; we depend not upon your superficial world for our sustenance or pleasure.

"Those of your kind who make themselves the interpreters of our intentions are naught but the picayunish deceivers of your civilisation. Let it again be said that we desire man no harm and wish only to pursue our independent existence on this, our mutual planet. We shall not influence nor bring to you discord in any medium.

"We are not doers of evil. Our world spans the inner gulf of your globe. We have existed since before your time. Had we wished harm upon you, we would also have been its receivers. We beg you a friendly farewell and hope our message will be heeded and find wide acceptance among those of your kind who find it necessary to concern themselves with our domain."

The screen then faded, without our having seen a clearly defined image of the person who had spoken. Luckily, Don had quickly written in his notebook what the voice had said to us.

The red lighting in the chamber suddenly became even deeper in tint, and all of us felt light-headed. Rick shouted that he was going to faint, and he started to fall but we caught him. Then we, too, had the same feeling and blacked out.

When we regained consciousness, we found ourselves lying outside the mine entrance. We still retained our personal effects, notebooks, pencil, wallets, etc., but all our equipment, such as safety hats, pickhammers and chisels, and our Geiger counter, had disappeared.

After returning to the States, Don found all the pages of his notebook burned or charred, as though it had been thrown into a roaring fire. The notebook cover, however, which was made of plastic, was surprisingly undamaged. All of us had worn wristwatches with radium dials. Some weeks later, the radium became inactive and the dials no longer glowed in the dark.

(Source: NEXUS was sent this item via the Internet, but we also found it in *Underground Alien Bases*, published in 1990 by Abelard Productions, Inc., PO Box 753, New Brunswick, NJ 08903, USA)









# REVIEWS

## BOOKS

Reviewed by Ruth Parnell

### THE MYSTERY OF THE MIN MIN LIGHT

by Maureen Kozicka

Published by M. Kozicka (1994), Australia  
ISBN 0-646-18711-2 (140pp s/c)

Price: AUD\$16.95 + AUD\$3.00 p&h in  
Aust; NZ/PNG add AUD\$6.00 p&h; S-E  
Asia add AUD\$7.00; UK/Eur/USA/  
Canada add AUD\$10.00

Available: **Australia**—Helen Kozicka, PO  
Box 20, Machan's Beach, Qld 4878.

One of the great mysteries of outback Australia is the phenomenon known as the Min Min light. Appearing as a sphere of energy or light, the Min Min has struck both awe and terror into the hearts of those who have witnessed its strange behaviour as it glides, streaks, dances and hovers over the landscape, arriving without any warning and disappearing without a trace.

Earth lights—if these are what the Min Min lights are—are by no means limited to Australia, but, judging by Aboriginal stories, they have been part of the landscape since ancient times. The stories have only become more prolific with European settlement.

Fascinated by the Min Min tales she'd heard, author Maureen Kozicka decided to field-research the phenomenon in 1992. Her focus was on Queensland sightings, although reports have been made through-

out the Australian mainland. The result is this compilation of 142 compelling eyewitness accounts. (Sadly, Maureen died before she could publicise her book.)

The phenomenon cries out for scientific analysis, but because of its fleeting and unpredictable nature this would obviously be a difficult task.

### OPEN SKIES, CLOSED MINDS

by Nick Pope

Published by Simon & Schuster (1996), UK  
ISBN 0-684-81664-4 (280pp h/c)

Price: AUD\$34.95; NZD\$45.00;  
STG£14.99

Available: **Aust**—Dist. by Simon & Schuster, ph (02) 416 3255; **NZ**—Dist. by Pan MacMillan, ph (09) 415 6677; **UK**—Dist. by Simon & Schuster Ltd, ph (0)1442 882222, fax (0)142 882288.

After decades of official silence, and despite the thousands of 'unexplained' UFO reports, the British Ministry of Defence stated in April this year that there was "no evidence which might substantiate the existence of such phenomena". Could Nick Pope's bosses at the MoD be the "closed minds" to whom he refers in the title of his book?

Nick Pope's job description at the MoD changed dramatically when he was appointed to the Secretariat (Air Staff)2a—the UFO Desk—in 1991 for a three-year term. This UFO novice thrust himself with gusto into researching his new subject area, interviewing eyewitnesses, comparing notes with ufologists,

raising Whitehall eyebrows, standardising UFO reporting procedures, accessing 'lost' archives, making press statements, and ultimately concluding that UFOs and extraterrestrials are real—and at least some of them should represent a real threat to the defence of the British realm (if not the entire world!). (See Pope's letter in NEXUS 3/05.)

Pope's book is a credible, open-minded thesis which highlights some intriguing, alarming, even convincing evidence from UFO cases in the UK—for example, the Rendlesham Forest incident—and abroad that can't be explained away. Something's definitely going on and, in Nick Pope's opinion, the public has a right to know exactly what.



# REVIEWS



## BOOKS

### ENCOUNTER

By Kelly Cahill

Published by HarperCollinsPublishers (1996), Australia

ISBN 0-7322-5784-0 (250pp p/b)

Price: AUD\$12.95; NZD\$17.95

Available: **Australia**—Distributed by HarperCollins, PO Box 321, Pymble, NSW 2073, ph +61 (0)2 9952 5000, fax +61 (0)2 9952 5666 (orders outside A/asia, ph/fax for p&h quote); **NZ**—Dist. by HarperCollins, ph (09) 443 9401.

NEXUS readers should recall Kelly Cahill's amazing and chilling story of her UFO close encounter whilst driving along a Victorian country backroad in August 1993 (see NEXUS 2/24). Her horrifying experience with a group of 'soulless', red-eyed, black humanoids is portrayed in detail in her long-awaited book, which is assured a place in the annals of ufology.

Kelly's report is significant for many reasons, not least because local ufologists and psychologists have been able to verify the accounts of another group of eyewitnesses present that fateful night—as Kelly was soon able to recall—and to gather evidence which confirms the validity of the encounter.

While Kelly had some conscious recollection of her experience, she needed time to remember much of the detail. This book is her account of how she pieced together the facts of her painful yet ulti-

mately life-transforming journey.

Her discovery process involved some unexpected, frightening alien visitations at night, as well as disturbing dreams and flashbacks. But it also brought Kelly some exhilarating metaphysical insights which have broadened her perspective on 'life, the universe and everything', and have given her the courage and determination to tell her story.

### SAFE AS HOUSES? Ill Health and Electro-stress in the Home

by David Cowan & Rodney Girdlestone

Published by Gateway Books (1996), UK

ISBN 1-85860-037-5 (224pp s/c)

Price: AUD\$25.95; NZD\$31.95;

STG£8.95; USD\$13.95

Available: **Australia**—Banyan Tree Book Distributors, ph (08) 363 4244; **NZ**—

Peaceful Living Publications, ph (07) 571

8105, fax (07) 571 8513; **UK**—Gateway

Books, ph 01225 835127; **USA**—

National Book Network, 4720 Boston

Way, Lanham, MD 20706.

The expression, "safe as houses", can never be taken for granted after reading this book. Our homes and our health can not only be affected by electromagnetic stress from power lines and appliances, but also by geopathic stress from errant Earth radiation. In fact, a combination of stresses from these sources can create an extremely harmful environment.

The significance of these radiation interplays has been highlighted in this collaboration of two specialists: David Cowan,

who dowses energy lines and helps people suffering from geopathic stress, and Rodney Girdlestone, a chemical engineer-turned-natural medicine teacher whose focus is on treating electromagnetic stress.

In this practical book they combine their expertise to make it easy for you to determine whether you, your home, your office and your neighbourhood are at risk.

Not only do you learn how to assess the dangers from man-made radiation sources, but also how they can be neutralised. The authors show a variety of techniques for achieving this.

As electromagnetic radiation will increasingly continue to affect the quality of our lives, we would be foolish not to incorporate the authors' advice into our health regimens.

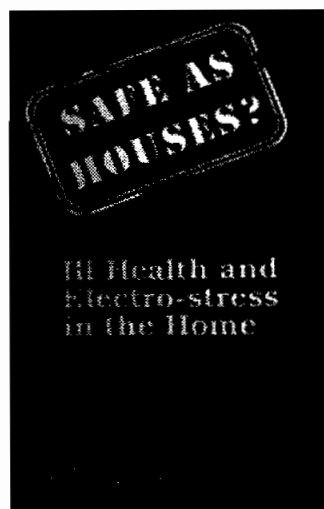





# REVIEWS

## BOOKS

### **FIELDS OF MYSTERY: The Crop Circle Phenomenon in Sussex** by Andy Thomas

Published by S.B. Publications (1996), UK  
ISBN 1-85770-096-1 (96pp s/c)  
Price: AUD\$15.00; NZD\$20.00;  
STG£7.95; USD\$13.50 (inc. p&h)  
Available: UK—NEXUS Office, 55  
Queens Rd, East Grinstead, West Sussex  
RH19 1BG, ph +44 (0)1342 322854.

The "fields of mystery" evocatively referred to here are none other than those fields of the English southeastern counties of East and West Sussex, in which a large number and variety of crop formations have been found each summer.

Author Andy Thomas's first pictogram encounter in 1991 inspired him to investigate the mystery, and together with other intrepid circle-hunters he soon became active with the Centre for Crop Circle Studies. Meantime, as Editor of the monthly journal, *SC (Sussex Circular)*, he's able to access a great deal of fascinating documentation about the phenomenon.

In *Fields of Mystery*, Thomas presents breathtaking 'circular evidence' in diagrammatic form and photographs (many in full colour), and describes each one's history faithfully and with flair. He touches on the early years of the phenomenon in Sussex, but turns his attention primarily to the formations of 1990 to 1995—some of which will already be familiar to you.

This is a welcome addition in the field of cerealogy, and the ground it covers is really a microcosm of a grand design which is resonating all around the world.

### **POPULAR ALIENATION: A Steamshovel Press Reader** edited by Kenn Thomas

Published by IllumiNet Press (1995), USA  
ISBN 1-881532-07-0 (343pp l/f s/c)  
Price: AUD\$30.00; NZD\$45.95 + p&h;  
STG£15.95 + £2 p&h; USD\$19.95 + p&h  
Available: Aust—NEXUS Magazine, PO  
Box 30, Mapleton, Qld 4560; NZ—NEXUS  
Office, PO Box 34735, Birkenhead,  
Auckland, ph (09) 416 7320, fax (09) 416  
7340; UK—Counter Productions, PO Box  
556, London SE5 ORL; USA—Adventures  
Unlimited, PO Box 74, Kempton, IL 60946.

One of the best 'conspirazines' around would have to be the Missouri-based *Steamshovel Press*. Its roots are in Beat-era sensibilities but its net is wide in terms of the 'underground' philosophies and sub-cultural viewpoints it taps into. *Popular Alienation* is a fitting title for this anthology of nine issues of *Steamshovel* (plus a never-before-published 'virtual' issue), for alienation has been a popular theme for quite some time.

A quick flick through this weighty collection makes you appreciate why certain seemingly unrelated subjects are more closely connected than you've been led to believe. In fact, *Steamshovel* is one of the few 'zines able to make valid links between JFK, CIA, LSD, UFO and MIB,

all in the one sentence! This *Reader* taps into the broader picture of conspiracy politics, particularly on the US front, and dishes up the nitty gritty details you won't find in the mainstream press on subjects as diverse as the Gemstone Files, Area 51 and Moon bases, the Turin Shroud, Reich's secret files, CIA mind control, the Mothman, Nazi science, the Trilaterals, Inslaw and more.

*Popular Alienation* is a feast for the conspiracy-hungry with its cross-disciplinary, tell-it-like-it-is approach, jam-packed with contributions from such notables as Noam Chomsky, Stanton Friedman, Allen Ginsberg, John Keel, Jim Keith, Timothy Leary, Jonathan Vankin, Robert Anton Wilson—as well as Kenn Thomas, editor of *Steamshovel*, whose latest exposé on Danny Casolaro and the 'Octopus' cabal begins in this issue of NEXUS.

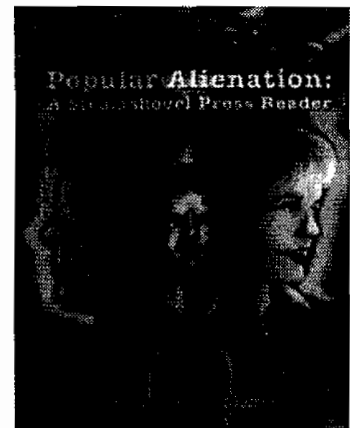

# REVIEWS



## BOOKS

### THE WHITE DEATH

by Julian Cribb

Published by Angus & Robertson/  
HarperCollins Publishers (1996), Australia  
ISBN 0-207-19041-0 (266pp p/b)  
Price: AUD\$16.95; NZD\$24.95  
Available: **Australia**—Distributed by  
HarperCollins, PO Box 321, Pymble NSW  
2073, ph +61 (0)2 9952 5000, fax +61  
(0)2 9952 5666 (orders outside Asia,  
phone/fax for p&h quote); **NZ**—Dist. by  
HarperCollins, ph (09) 443 9401.

One of the major public health concerns today is the risk of animal diseases finding their way across the species barrier into the human population.

In *The White Death*, award-winning Australian science writer and journalist Julian Cribb delves into the issues surrounding the origin of AIDS and concludes that monkey experiments performed over four decades ago could have inadvertently transferred a monkey virus to humans, with dire consequences.

There is overwhelming evidence in the vaccination literature to suggest that contaminated monkey kidney tissue cultures have been used in the production of all sorts of vaccines, including polio. Here, Julian Cribb, by linking the African polio vaccination campaign with the trail of AIDS, postulates that these alien microorganisms could well have mutated once introduced to human hosts.

Cribb's thesis is a warning that new disease plagues will inevitably emerge which modern science will be at a loss to treat, regardless of their source.

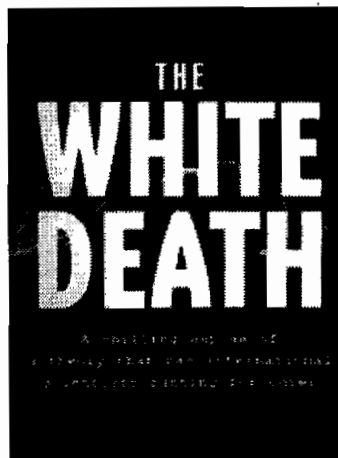

### SPIES: The Secret Agents Who Changed the Course of History

by Ernest Volkman

Published by J. Wiley & Sons (1996), USA  
ISBN 0-471-15403-2 (s/c)  
Price: AUD\$28.95; NZD\$39.95;  
STG£12.99; USD\$16.95; CAN\$23.95  
Available: **Aust**—Dist. by Jacaranda  
Wiley, ph (02) 805 1100; **NZ**—Jacaranda  
Wiley, ph (06) 355 1298; **UK**—J. Wiley,  
ph 01243 779777; **USA/Canada**—John  
Wiley & Sons, ph (212) 850 6000.

As journalist Ernest Volkman reminds us, espionage is among the oldest professions in the world, but the 20th century has seen it become increasingly institutionalised, and further compartmentalised with the establishment of the electronic information age and its ongoing technological 'improvements'.

In *Spies*, Volkman presents a pastiche of those 'intelligence agents' who have made their mark on world events this century—for better or worse, whatever side or sides they might have been on at the time—and inspired a thousand-and-one spy thrillers.

Volkman is objective in his approach to these individuals and the importance of their work, but he neither glamorises nor glorifies—that would be irresponsible. Spies, he insists, are governed by three commandments: (1) Don't get caught; (2) If you get caught, the agency has never heard of you; and (3) No other commandments are necessary. Unfortunately, the reader is left wanting for more, as each entry in *Spies* averages only a few pages, and recent espionage dramas are excluded (probably for good reason).

### MARS/EARTH ENIGMA: A Sacred Message to Mankind

by DeAnna Emerson

Published by Galde Press (1996), USA  
ISBN 1-880090-18-X (314pp s/c)  
Price: STG£18.50; USD\$19.95 + p&h  
Available: **UK**—Gazelle Book Services,  
Lancaster, ph 01524 68765; **USA**—  
Adventures Unlimited, PO Box 74,  
Kempton, IL 60946, ph (815) 253 6390,  
fax (815) 253 6300.

The mysterious Face and pyramidal structures on Mars, identified and enhanced from photographs taken by NASA's *Viking Orbiter* in 1976, have captured our imagination and sparked calls for the space agency to be more open in the interests of scientific enquiry and the



# REVIEWS

public right-to-know.

DeAnna Emerson, a writer, scholar and student of ancient religions and archaeology, argues in *Mars/Earth Enigma* that the structures are the marks of an advanced civilisation—but one which has had a significant relationship with Earth.

So what does it all mean? Emerson has discovered markings, or inscribed symbols, on the Martian Face which can be likened to those symbols used by ancient goddess-worshipping societies on Earth, and she includes many examples of such glyphs and scripts to prove her point. She observes that the same sacred geometric symbols can be seen in the mystical Pythagorean numbers and even in many of the crop circle pictograms, and suggests that they may even contain within them the keys to higher-dimensional physics.

This is a fascinating, multidisciplinary treatment which not only explains the heritage of the matriarchal societies of pre-history, but suggests a much stronger Mother Goddess connection with Mars than is usually recognised. Emerson also raises important issues concerning equality of the sexes, the Vatican's role in the suppression of women, the condition of world power structures, and the existence of extraterrestrial life.

## **I AM WITH YOU ALWAYS: True Stories of Encounters with Jesus by G. Scott Sparrow, Ed.D.**

Published by Bantam (1995), USA ISBN 0-553-37523-7 (231pp s/c)  
Price: AUD\$17.95; USD\$11.95; CAN\$16.95  
Available: **Australia**—Distributed by Transworld Publishers, 40 Yeo St, Neutral Bay, NSW 2089, ph +61 (0)2 908 4366; **USA/Canada**—Bantam/Doubleday, ph (212) 354 6500.

The Christ encounter phenomenon has been recorded throughout the last 2,000 years, but in contemporary times its experience would seem to be more widespread than is generally believed. In fact, it's surprising just how common it is.

Psychotherapist Gregory Scott Sparrow, who specialises in an innovative transpersonal dreamwork therapy, has been researching the Christ encounter for the last five years and has amassed a variety of extraordinary accounts from ordinary people whose lives have suddenly become transformed for the better—just when they needed them to be.

Sparrow defines the Christ encounter as "any experience in which a person perceives the presence of a being whom he or she identifies as Jesus or Christ", and he excludes encounters with other identified or unidentified spiritual beings. These encounters can come in dreams, waking visions or near-death experiences, and happen unexpectedly to people of all ages from all walks of life (not necessarily to Christian believers), leaving witnesses in no doubt as to their reality.

In his research, Sparrow has identified several categories of Christ encounter: awakening, physical healing, emotional healing, confrontational, initiatory, instructional and confirmational. The common thread running through all these personal stories is an experience of the power of divine love and wisdom, a renewed conviction to life and living, and a feeling that Jesus Christ is with us always—just as he's supposed to have promised. These are moving stories, whatever your belief system.

## **THE PARADIGM CONSPIRACY by Denise Breton & Christopher Largent**

Published by Hazelden (1996), USA ISBN1-56838-106-9 (399pp h/c)  
Price: USD\$23.95 + foreign p&h; CAN\$32.95

Available: **USA**—Hazelden, PO Box 176, Center City, MN 55012-0176, ph (612) 257 4010.

Everything we think, feel and do is shaped by paradigms, our mental models. When individual experience combines with the collective, a larger paradigm is created, which we call consensus reality. The fact is, we can become so system-bound that we don't even realise the model no longer works for ourselves or society, let alone be able to change it. We unwittingly participate in a big lie.

Authors Denise Breton and Christopher Largent, a husband-and-wife writing-and-teaching team specialising in philosophy and comparative religion, argue in *The Paradigm Conspiracy* that our systems—government, education, religion, business, science, cultural patterns and even the family itself—can conspire to violate our human potential.

These systems perpetuate themselves by promoting addictions to substances, emotions and processes which stifle individual

# REVIEWS



## BOOKS

freedom and creativity, making us become people we never wanted to be. How can we be truly healthy and happy when our systems are dysfunctional?

We are all conspirators in what we call reality, and so, according to the authors, we can all conspire to bring a new paradigm into existence. There is no point trying to fix unworkable models based on fear, greed and power; instead, we need to put into place systems and structures that acknowledge and nurture the soul and spirit. Inspired by ideas from new science, spiritual traditions and history, Breton and Largent describe workable paradigms that prove this can be done.

### **THE NATURAL WAY TO BETTER BABIES: Preconception Health Care for Prospective Parents**

by Francesca Naish & Janette Roberts  
Published by Random House (Aust) (1996)  
ISBN 0-09-18135-0 (382pp s/c)  
Price: AUD\$24.95; NZD\$29.95

Available: **Australia**—Dist. by Random House, Milsons Point, NSW 2061, ph +61 (02) 9954 9966; orders outside A/asia, phone/fax for p&h quote; **NZ**—Random House, ph (09) 444 7197.

The focus of *...Better Babies* is on preconception care for prospective parents; for, as studies have shown, if both of them can improve their general health and avoid hazardous lifestyle and environmental factors in the months leading up to conception, they greatly increase their prospects of having a child who is physically, emotionally and mentally healthy—and will stay that way.

Natural fertility management is an holistic approach that is practical and successful, as authors Francesca Naish and Janette Roberts can confidently attest after many years' clinical experience in natural reproductive health care. Here, they explain what prospective parents can do in everyday life to prepare better for conception, giving guidance on diet, lifestyle and exercise, on reducing stress and staying positive, on detoxifying oneself and one's surroundings, and improving general male and female reproductive health.

Their advice on natural contraception and conception is responsible and enlightening. Indeed, they suggest that attempts to conceive be delayed until both partners

can properly attend to their own health and well-being—when conception can be a better-timed, conscious, optimistic joint effort conducive to a healthy baby from the outset.

If you're contemplating having a child, whether for the first time or not, this book is essential reading.

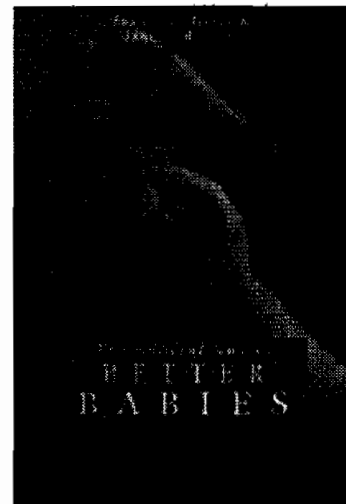

### **LIVING WITH HIV/AIDS: A Practical Guide for Staying Well**

by Peter de Ruyter  
Published by Allen & Unwin (1996), Australia

ISBN 1-86448-080-7 (309pp s/c)  
Price: AUD\$29.95 + o/s p&h; NZD\$39.95  
Available: **Australia**—Dist. by Allen & Unwin, St Leonards, NSW 2065, ph +61 (02) 9901 4088, fax +61 (02) 9906 2218; **NZ**—Dist. by Archetype Book Agents, ph (09) 638 7008, fax (09) 638 7007.

As a natural therapist with over 10 years' experience in treating HIV and AIDS patients, Sydney-based Peter de Ruyter can write with some authority on alternative, holistic treatments that are practical, effective and safe, without the damaging side-effects that are often characteristic of orthodox drug options.

In *Living with HIV/AIDS*, de Ruyter argues that the first hurdle for medical practitioners and their patients to overcome is a mindset which denies the validity of alternative ways of looking at and dealing with the condition. He contends that medical science will never come up with a cure for AIDS unless it explores new territory—where the environment in which a micro-organism develops is as important as the organism itself—and includes Lifeorce in the total picture.



# REVIEWS

But, with so much at stake in AIDS medical research—money, power, reputations—a paradigm shift may well be a long way off.

De Ruyter advocates a higher-dimensional approach to health and healing, one that incorporates metaphysical concepts and self-help, mind-over-matter techniques such as creative visualisation. These are essential adjuncts in a successful treatment, which should also include appropriate diet, lifestyle and supplementation with natural medications—which he describes in this book with reference to specific symptoms.

Relief and even cure of HIV and AIDS conditions is achievable, according to de Ruyter, but sufferers must be prepared to adopt life-promoting habits and strategies and stick with them wholeheartedly. That way, they can empower themselves instead of placing their faith in a system where their chances are slim.

## **KEEPER OF GENESIS: A Quest for the Hidden Legacy of Mankind** by Robert Bauval and Graham Hancock

Published by Heinemann (1996), UK ISBN 0-434-00302-6 (h/c), 0-434-00305-0 (l/f s/c) (370pp)

Price: AUD\$24.95 (s/c); NZD\$29.95 (s/c); STG£16.99 (h/c)

Available: **Aust**—Dist. by Reed Books, ph (03) 9245 7183; **NZ**—Reed Books, ph (09) 480 6039; **UK**—Reed Consumer Books, London, ph +44 (0)171 581 9393.

*Keeper of Genesis* is another remarkable work that throws conventional wisdom about our ancient origins into turmoil. Here, Robert Bauval (*The Orion Mystery*) and Graham Hancock (*Fingerprints of the Gods*) expand on Egypt's mysteries and the Great Pyramid's Osiris/Orion and Isis/Sirius links by reversing the astronomical clock, using computer simulations of star maps and precessional cycles.

The only period when the star patterns exactly match the orientation of structures around the Giza necropolis is the year 10,500 BC!

Furthermore, this period marks the beginning of a precessional half-cycle, the dawning of the Age of Leo and the "First Time"—no better heralded than by the Great Sphinx, built to face exactly due east at precisely the right time: the vernal equinox of 10,500 BC. This would seem

to support geological and climatological evidence that the Sphinx is much more ancient than archaeologists and Egyptologists dare contemplate: conservatively, 7,000 years; possibly well over 15,000 years!

Speculation is rising about a legendary, underground "Hall of Records" in the vicinity of the Sphinx, particularly after a recent seismographic survey may have identified such a chamber below the monument's front paws. But Bauval and Hancock have superimposed a star map onto the Giza layout which points to another, deeper location for this chamber—below the rear of the Sphinx. They now urge the Egyptian authorities to allow full public disclosure of the progress and findings of any new searches of Giza's tunnels. (See Hancock's update in this issue of NEXUS.)

These revelations have profound implications. Could the Giza structures have been back-engineered to fit the star patterns of the "First Time"? Could blueprints for the pyramids have been passed down from an earlier, more advanced civilisation? Could the Sphinx be the grand design of an even earlier culture which built the monument to align with the future stellar projection of 10,500 BC? The riddle is still being unravelled.

## **FROM ATLANTIS TO THE SPHINX** by Colin Wilson

Published by Virgin Publishing (1996), UK ISBN 1-85227-526-X (304pp h/c)

Price: AUD\$39.95; NZD\$49.95; STG£15.99; USD\$n/a; CAN\$32.95

Available: **Aust**—Dist. by Hodder Headline, ph (02) 638 5299; **NZ**—Dist. by Hodder Moa Beckett, Auckland, ph (09) 478 1000; **UK**—Dist. by Virgin Publishing Ltd, ph 0181 968 7554; **USA**—London Bridge, Buffalo, NY, ph 1-800 805 1083, fax (416) 445 5967.

Best-selling author Colin Wilson admits that his inspiration for this book was the research of the noted French esotericist-Hermetic philosopher, René Schwaller de Lubicz, who, from earlier this century, claimed that the ancient Egyptians possessed "a grand, interrelated and complete system of knowledge". He also believed that the erosion patterns on the Great Sphinx are caused by water, not wind and sand—an observation only confirmed in 1991 by US geologist Robert Schoch, and

# REVIEWS



## BOOKS

still disputed by Egyptologists.

*Atlantis to the Sphinx* implies a connection to which Schwaller alluded: that the Sphinx had to have been built by a civilisation which arrived at Giza intact and highly developed—perhaps from Atlantis before its demise?

Colin Wilson argues that what enabled the Egyptians to perform such wondrous feats was their mindset—a unified, bicameral consciousness in direct contact with Nature and the Universe—which was subjugated in 1,250 BC by forces and events which favoured left-brain traits: mindsets which may have kick-started the evolution of individuality but at the expense of a glorious, collective heritage.

Fortunately, what has characterised human evolution these last few centuries is the development of imagination together with intellect. Perhaps we can yet build a bright future and understand our mysterious past according to our own devices.

### **SECRET POWER: New Zealand's Role in the International Spy Network** by Nicky Hager

Published by Craig Potton Publishing (1996), New Zealand

ISBN 0-908802-35-8 (299pp s/c)

Price: NZD\$34.95 + p&h (phone/fax for foreign p&h quote)

Available: **New Zealand**—Craig Potton Publishing, PO Box 555, Nelson, ph +64 (0)3 548 9009, fax +64 (0)3 546 9192.

For years we have suspected that intelligence agencies electronically eavesdrop on our phone conversations, faxes and

telexes, and now our e-mail and web sites, by tapping into 'key words'. This new book, *Secret Power*, by long-time New Zealand peace activist Nicky Hager, confirms our worst fears by spilling the beans on the Echelon system and its frightening implications as the tool of a global espionage network.

New Zealand's spy agency, the GCSB, uses Echelon for the automatic interception of communications routinely picked up by its Waihopai satellite tracking station and Tangimoana listening station and transmits them to the US National Security Agency's facilities across the Pacific. With junior membership (with Australia and Canada) in the secret UKUSA 'alliance', NZ is assigned to monitor communications in the South Pacific and Antarctica—and, in this post-Cold War era, that means spying on individuals and companies as well as governments.

Readers familiar with HAARP and Bruce Cathie's research into Earth grid harmonics will glean an extra dimension from *Secret Power*. This is a diligently researched exposé which is already proving to be an embarrassment to many government agencies and politicians.

## SOFTWARE

Reviewed by Duncan Roads

### **CYBERSAYER™ version 2.1** by Majistyks (1995), Australia

Price: AUD\$70.00 + AUD\$5.00 o/s p&h

Available: **Australia**—Majistyks, PO Box 550, Maleny, Qld 4552, ph +61 (0)74 99 9060, fax +61 (0)74 99 9818, e-mail: cybersyr@majistyks.com.au; web page: <http://www.majistyks.com.au> (see ad this issue).

To run this nifty piece of software on your computer, you will need a PC (or Mac) that runs Windows 3.1 or later. *CyberSayer* occupies about 3MB on the hard-drive. The Shareware version (see their web page) requires slightly less.

*CyberSayer* was developed as an interactive tool, to be used to 'help you change your life'—for the better. *The Eye of Horus* is the first component released by the developers. It draws on a huge database of inspirational or interesting sayings and messages and usually finishes with something relevant for the day.

At least mine did! A great package.

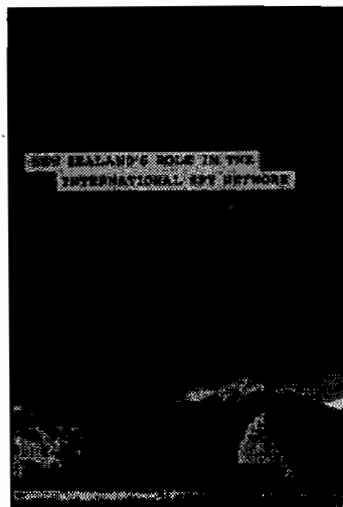



# REVIEWS

## AUDIO

Reviewed by Richard Giles

### BLOOD OF THE LAND

by Burning Sky

Produced by Robert Doyle for Canyon Records (1995), Phoenix, AZ, USA  
Price: AUD\$18.95 (cass.), AUD\$28.95 (CD); USD\$9.98 (cass.), USD\$15.98 (CD) + \$2.50 p&h (54mins)

Available: **Australia**—New World Productions, ph (07) 3367 0788; **USA**—Four Winds Trading Co., AZ, ph 1-800 456 5444; Canyon, ph (602) 266 4823.

Burning Sky use a blend of Native American flute, acoustic guitar and percussion. The haunting North American flute has always held that canyon-echo sound, summoning generations of ancestors. It's used skilfully here to capture the lost power of a desolate tribe or the beauty of secret lovers meeting in the moonlight. A fine combination of percussion and guitar adds to the depth and rhythm.

### CELTIC DESTINY

by Bruce Mitchell

Produced by Bruce Mitchell for Oasis Productions (1995), Toronto, Canada  
Price: AUD\$19.95, CAN\$10.99 (cass.); AUD\$29.95, CAN\$15.99 (CD) (58mins)  
Available: **Aust**—Movieplay Australia, ph (02) 9905 0199; **Canada**—Oasis Productions, ph (416) 467 8820.

The Celtic revival has offered some beautiful and inspiring music. Bruce Mitchell, producer of two previous albums of Celtic sounds, has worked as a musician in folk and rock groups, and scored film and TV documentaries. *Celtic Destiny* mixes some gentle and lively traditional songs with his own compositions. The work on some of the tracks is beautiful and flowing, with rollicking penny whistles, recorder and violin joining in. Excellent Celtic material.

### THE TRANCE OF SEVEN COLORS

by Maleem Mahmoud Ghania

Produced by Bill Laswell for Axiom/Island Records (1994), USA  
Price: AUD\$19.95, USD\$10.00(cass.); AUD\$29.95, USD\$16.00 (CD) (71mins)  
Available: **Australia**—Island Records, Sydney, ph (02) 9207 0500; **USA**—Island Records, New York, ph (212) 603 3947.

Any production involving Bill Laswell's

hand is certain to be something special. He has a grand collection, released via Axiom, to his credit. Maleem Mahmoud Ghania, chief musician on this album, draws his skill and learning from his ancestors, the African Peul and Bambara from Mali and Guinea.

The role of the Maleem (master) is to lead the musical ceremony, via instrument and spirit, through the seven colours of the trance. Compelling, exciting Moroccan-style music backed on several tracks by blues player Pharoah Sanders. Powerful, hypnotic sounds.

### IF THEN...ELSE

by Candice Pacheco

Produced by Candice Pacheco for RGB Records (1995), Sausalito, CA, USA  
Price: AUD\$19.95, USD\$9.98 (cass.); AUD\$29.95, USD\$15.98 (CD) (47mins)  
Available: **Aust**—MRA Entertainment, ph (07) 3849 6020; **USA**—RGB Records, ph (415) 331 3200.

Candice Pacheco is little-known outside the USA. Her experimental, sampled music, though, is at the forefront of the new techno-world-fusion style that's growing today. This album is a collection of sampled material, including Native American flute, Middle Eastern oud and tambourine, finger cymbals, the dumbek and Baroque flute. The effect is somewhat reminiscent of *Deep Forest* at times. If you like upbeat world voice/percussion techno-music, you'll really appreciate this.

### A RIVER OF SOUND: A Collection

Produced by Sarah Power  
Hummingbird Productions (1995), UK  
Price: AUD\$19.95, STG£7.95 (cass.); AUD\$29.95, STG£11.30 (CD) (63mins)  
Available: **Aust**—Festival Records, ph (02) 9660 4022; **UK**—Virgin Records, ph 0181 964 6000.

Music on *A River of Sound* was recorded live for the BBC Northern Ireland radio programme, to chart the changing direction of Irish traditional music. It features 130 artists with a wide range of tunes and styles from the wild fiddler to the sedate harpist. Instruments include accordion, piano, tin whistle, cello, bodhrán, mandolin, harmonica, concertina and uilleann pipes. If you love the sound of Irish reels, jigs and traditional voice melodies, you'll love this!

Continued from page 22

<sup>13</sup>(a) Constantine, Alex, *Psychic Dictatorship in the USA*, Feral House, Portland, Oregon, USA, 1995 (contains an excellent chapter on RMCT);

(b) Ostrander, Sheila and Lynn Schroeder, *Psychic Discoveries Behind the Iron Curtain*, Prentice-Hall, USA, 1970;

(c) Ostrander and Schroeder, *Superlearning*, 1982.

<sup>14</sup>(a) Refer to the works of Wilhelm Reich, inc. *The Function of the Orgasm*, 1927;

(b) Refer also to Robert Pavlita, who rediscovered psychotronic generators from an old alchemical text. These devices store psychic energy, rather like Reich's orgone generators that store biophysical fields.

(c) Mann, Edward W., *Vital Energy and Health*, 1989.

<sup>15</sup> Refer to Ingo Swann's papers on the signal-to-noise ratio, to be found on the Internet under the RV maestro's name.

<sup>16</sup> Refer to collected works of Carlos Castaneda, yogic texts, Zen manuals, etc.

<sup>17</sup> Edelman, Gerald, *Bright Air, Brilliant Fire*, Basic Books, New York, 1992.

<sup>18</sup>(a) Tansley, David, *The Raiment of Light: A Study of the Human Aura*;

(b) Smith, Cyril, *Electromagnetic Man*, 1989.

<sup>19</sup>(a) Refer to the entire work of Dr Rupert Sheldrake, inc. *The Presence of the Past*, 1988; *A New Science of Life: The Hypothesis of Formative Causation*, 1985;

(b) Bohm, D., "Morphogenetic Fields and the Implicate Order", *ReVision* 5:41-48.

<sup>20</sup> Cohen, Philip, "Child's lethal gene fault heals itself", *New Scientist*, 20 July 1996.

<sup>21</sup> To amplify this small RV effect in humans, I have developed a methodology called Group Augmented RV, which can enable any group to use RV to study military sites or off-world alien phenomena.

<sup>22</sup> Refer to articles on natural healing on the Internet.

#### Further References

• Akwei, John S., "Covert Operations of the US NSA", *NEXUS Magazine*, vol. 3, no. 3, 1996.

• Brown, Courtney, *Cosmic Voyage: A Scientific Discovery of Extraterrestrials Visiting Earth*, Penguin Books, 1996.

• Forsyth, Richard, "Room with a Remote View", *Encounters*, issue 10, August 1996. This is an article about the author.

• Matthews, Robert, "CIA Signed up Psychics as Spooks", *The Sunday Telegraph* [UK], 4 August 1996.

• McMoneagle, Joseph, *Mind Trek*, 1993.

• Paranormal Management Systems has produced an information pack on Remote Viewing. To obtain a copy, please send STGE2 (STG£5 outside the UK) to PMS, PO Box 2749, Brighton, BN2 2DR, UK. PMS web site address: <http://www.fastnet.co.uk/pms>

• Small, Marie-Louise, "Psi Spies", *Encounters*, issue 7, May 1996. This issue comes with the great little book, *America's UFO Cover-up*, by Marie-Louise Small. Anyone interested in US NWO conspiracy theories about alien masters should read this, as well as *Cosmic Top Secret: America's Secret UFO Program*, by William Hamilton III, 1992. Page 108 makes grisly reading and, if true, verifies much of what I have been stating. For information on how to visit these US underground sites, please send STGE3

(STG£5 outside the UK) to PMS, PO Box 2749, Brighton, BN2 2DR, UK. This gives all the information any group will need to start RV exploration of US/alien sites.

• Visit Dr Jessica Utts' web site for details on the scientific verification of RV, and as a stop-off point for other RV sites and places of interest. Web site address: <http://www.jsc.com>

#### About the Author:

Turan Rifat was born in Brighton in 1957. He has a university science degree and another in education. Whilst doing his Ph.D., the author decided he'd had enough of mechanistic science, so for the past 15 years he has been researching the paranormal, with the aim of developing its physics, as well as carrying out numerous workshops on healing and personal development. His research task took rather longer than imagined, and led to some unfortunate confrontations with 'evil' forces—MI5 being the least of these.

Recently, he set up Paranormal Management Systems (PMS), the only company in Europe with expertise in biophysical RMCT that can come close to what the Russians have developed and which outstrips the US knowledge base in the biophysical area. PMS evaluates this military-domain RMCT material and develops it in terms of its applications for business in enhancing profitability and performance.

Turan Rifat offers courses and consultancy in the RV/RI field. He is currently writing a book, *Remote Viewing: The Story of the Real X-Files*, and is planning to follow up this article with one on ESP and telepathy, with reference also to synthetic telepathy.



Continued from page 49

So the woman went to this doctor in North Phoenix. He gave her these capsules, a month-and-a-half worth of pills. She took this material, at a hundred milligrams, for a month and a half. At the end of the month and a half she went back to the oncologist. She had no cancer anywhere in her body! I didn't even know who the woman was. I had nothing to do with giving her the material.

I got this phone call and this woman said, "Mr Hudson, I don't know who you are or what this material is, but it is really fantastic material."

So she told me the story. Apparently the material didn't work on the 57-year-old woman.

We were then back at the University of Chicago having cancer studies done with mice. What we found was it killed the cancers of about half the mice, but in the other half the cancers grew faster.

But at the end of the study the cancer researchers injected the mice with oestrogen, which should have caused the cancers to even grow faster. Instead, as soon as the oestrone hit their bodies, within 24 hours

all the cancers were gone.

What I suggest to women right now is that anyone who is over 40 years of age should consider taking DHEA [dehydroepiandrosterone] or some female hormone, because the female hormone plays an important role in the treatment of the breast cancer. Now I'm not presenting this to you as technical information. I'm presenting this to you as my experience and what I can tell you about it.

We also had a doctor in Florida who was giving the material to a pancreatic cancer patient last November. The patient was dramatically losing weight and was not expected to survive, so they were desperate for anything. He took this material for 60 days and has now regained all his weight and is doing just great today. The doctor doesn't understand it. He is just totally blown away about how it could happen, because nobody survives pancreatic cancer.

This material is not an *anti*-anything. It is not anti-AIDS. It is not anti-cancer. It is *pro*-life. It literally is the *spirit*. The material is not here to cure AIDS. It is not here to cure cancer. The material is here to perfect our bodies. It makes our bodies be in the state they are supposed to be in.

It is our own immune system that fights and cures the disease. If you can correct your DNA at every cell in your body, if you can correct the damage that's been done that brought about the cancer, if you can correct the damage that has been brought about by the virus, the AIDS, you literally will become a perfected being. You will return to the original healthy state you were meant to be in.

This is not a medicine. This material is, in fact, a philosophical material. It is here to enlighten us and to raise the consciousness of mankind. If, in doing that, it happens to cure diseases, so be it. It's real hard for most of us to understand that this is what it is all about... ∞

#### Endnotes

<sup>1</sup> Puthoff, H. E., "Gravity as a Zero-Point Fluctuation Force", *Physical Review A*, vol. 39, no. 5, 1 March 1989.

<sup>2</sup> *Secrets of the Alchemists*, Time-Life.

For further information about ORMEs and membership of the Science of the Spirit Foundation, write to PO Box 25709, Tempe, AZ 85285, USA.

Continued from page 66

An Air Accident Report, allegedly written by General Nathan Twining of the Air Materiel Command at Wright Field and published by the late Len Stringfield, mentions a "Flying Disc Aircraft found near White Sands Proving Grounds" at some time before 16th July 1947, the date of the report. Since the report covers the full technical evaluation of the craft, we can assume the crash happened at least one month beforehand, if not more.<sup>53</sup>

Stringfield quoted another witness, Major V. A. Postleweith of US Army Intelligence, who had seen a classified telex mentioning a disc crash "in the vicinity of the White Sands Proving Grounds".<sup>54</sup>

#### CRASH AND RETRIEVAL WITNESSES

We located several witnesses to a 'crash' that very day in question: 31st May 1947, in the evening hours. Fred Strozzi, a local rancher who lived just a few miles away from the crash site, claimed to have seen a meteorite "bigger than a basketball" falling during that time and in the area in question, according to Betty and Smoky Pound, another local rancher couple.<sup>55</sup>

Unfortunately, Strozzi passed away years ago, so we couldn't ask him for details.

But the same 'meteorite' had also been seen by a group of Native American children of the Acoma tribe who went to school in Gallup, New Mexico. That day, 31st May—which one of them remembered quite clearly because it was just before her birthday—was a very hot day, so they played in the evening when it had cooled down. "Suddenly the whole sky was lit up as if it was daytime," one of them recalled. "In less than four seconds, a big ball of fire glided silently over our heads from left to right, i.e., northwest to southeast"—which is the direction of Socorro. "The light was so bright that we kids held our hands before our faces to protect our eyes."<sup>56</sup>

Two days later, most of the children had blisters on their hands and arms—"itchies" as they called them. We received a letter from the daughter of one of the witnesses and interviewed two others, one on the phone, the other on camera.<sup>57</sup> A meteorite wouldn't cause blistering like this. According to the cameraman, when he moved in about 24 hours later, the crashed disc was still hot and there was the danger of a fire, so we can indeed assume that the

craft was a 'fireball' when it crashed in the late hours of 31st May 1947.

Did the local newspapers cover the 'meteorite' sighting? Ted Loman tried to find out, and visited the office of the *Socorro Chieftain*. He was told that in the late 1960s a fire destroyed some of the papers and that, in fact, some were missing—those between 10th May and 15th June 1947. At the suggestion of the editorial assistant he spoke to, Ted tried at the library of the local mining university, where he found microfilms of all the issues of the paper—with the exception of those between 10th May and 15th June 1947. His attempt to find them in the Rio Grande Collection of the New Mexico State University at Las Cruces, New Mexico, was also unsuccessful.

Bob Shell tried at the neighbouring town of Magdalena. Again, all papers from that period were missing. He was told, "You won't find them. I have been looking for them for years and nobody has them." He also tried at the Zimmerman Library of New Mexico, without success.

According to the cameraman, the craft was delivered on the back of a flatbed truck to Wright Field, Ohio, by the middle of

June 1947. A witness, Howard Marston, a civilian engineer who worked at a testing laboratory at Wright Field in the summer of 1947, claims he was present "when they brought in a disc... It was on the trailer of a truck, covered with tarpaulins. They unloaded it in a hangar. I saw it from a distance when they uncovered it. It was a metallic disc, about 30 to 40 feet in diameter," Marston told me when I interviewed him.<sup>58</sup>

#### WITNESSES TO THE FILM'S ORIGIN

We located four eyewitnesses who had seen footage from the same stock as the Santilli film in the possession of the US military and intelligence—a fact recently confirmed by USAF Capt. John McAndrews.<sup>59</sup>

Master Sgt Bob Allen was security coordinator at a top-secret test site near Tonopah, Nevada. When he was briefed for his work, he was shown films for about two-and-a-half hours. When he saw the Santilli film on TV he immediately recognised them as part of the same stock. "I saw three autopsies," he told me. "During one, Truman stood behind the glass screen in the autopsy room. He wore a surgeon's

face-mask, but one could see it was Truman. After a few days the first one died, then the second. They said, 'Damn, they are dying like flies and we have to find out if they have any hostile intentions and what they are doing here. We must find a way to keep the fourth alive.' That's why the autopsies were done. The fourth extraterrestrial lived for another two years..."<sup>60</sup>

Sgt Clifford Stone, US Army, was stationed at Fort Ley, Virginia, in 1969. He was part of a Nuclear/Biological/Chemical Accident (NBC) Quick Reaction Team. He said, "My mission on that was to be the NBC NCO, the communications NCO. I had the opportunity to take our Lieutenant to Fort Belvoir, Virginia. At Fort Belvoir, myself and another person, a person from the Air Force, an airman, went to gallivant around and went up the stairs in an auditorium there, and we went into one room and sat down, and there was this plexiglass window down into the theatre...and they were watching down there what we believed to be trailers of science-fiction movies.

"There were these common saucer-shaped UFOs, cigar-shaped UFOs...and

you also had bodies. The airman and I went ahead and tried to figure out what movies these came from because we had an interest in SF... There were several types of bodies... When we did this, some people came in and told us to follow, in no uncertain terms." Both were arrested and underwent an "intensified debriefing" which took four nights and five days. "When I saw the Santilli tape, I saw the pictures first: they were haunting, because they took me back to this day in 1969, to these movies that they were watching. There were bodies that looked very, very, very close to that one. And there were alive ones, also. I have knowledge that there is footage within a tent. I have knowledge of a film with—if that is not Truman in the film, it is a very convincing double."<sup>61</sup>

On 26th June 1995, the British researcher Colin Andrews visited Ray Santilli in the presence of the Japanese researcher Johsen Takano, who advises the Japanese Government in UFO matters, and Dr Hoang-Yung Chiang of the National Research Centre for Biotechnology in Taipeh, Taiwan. Dr Hoang-Yung teaches

Continued on page 92

Continued from page 91

at the Cultural University and the Medical University of Taipeh and, through his initiative, ufology is now officially recognised by the Taiwanese Government as a scientific discipline.

After a private viewing, both Takano and Hoang-Yung told Andrews they had seen the film before: Johsen, when his government had requested UFO information from the US Government, which was then brought to Tokyo by a CIA courier; Hoang-Yung, when he had visited the CIA's headquarters in Langley, Virginia.<sup>62</sup>

### CONCLUSION

While nobody has been able to present any proof that the Santilli autopsy footage was faked, we have some convincing indications that the film might very well be genuine. If it is a hoax, it is definitely the most ingenious fake of the century.

Instead of continuing the polemic of the last year or so, serious UFO researchers should continue to evaluate the evidence and search for the truth, in what might turn out to be the most provocative proof yet that we are not alone in the Universe. ∞

### Endnotes

- <sup>1</sup> Jeffrey, Kent, "Santilli's Controversial Autopsy Movie", *MUFON UFO Journal*, Seguin, Texas, USA, no. 335, March 1996.
- <sup>2</sup>(a) Mantle, Philip (ed.), "The Roswell Film Footage", *UFO Times*, BUFORA, Batley, England, no. 36, Jul/Aug 1995;
- (b) Santilli, Ray (ed.), "Operation Anvil" (press release), London, England, 1995.
- <sup>3</sup> Shell, Bob, personal communication, December 1995.
- <sup>4</sup> Santilli, Ray, "My Story" (press release), London, 1995.
- <sup>5</sup> Santilli, Ray, Conference on the CompuServe Encounters Forum, 25 March 1996.
- <sup>6</sup> Shell, Bob, personal communication, 18 April 1996.
- <sup>7</sup> Kiviat, B. and D. Roehring, *Alien Autopsy: Fact or Fiction?*, TV broadcast, Fox Network, USA, 29 August 1995.
- <sup>8</sup> VonKeviczky, Colman, "Autopsy of a Human-like 'Freak' Body" (report), New York, USA, 23 October 1995.
- <sup>9</sup> *ibid.*
- <sup>10</sup>(a) Letter from Eastman Kodak Co., Hollywood, USA, June 1995 (without date);
- (b) Letter from Kodak Ltd., London, UK, 14 June 1995.
- <sup>11</sup> Shell, Bob, "Summary of Points in Physical Research on Film Dating" (report), Radford, Virginia, USA, 6 September 1995.
- <sup>12</sup>(a) Personal information from Terry Blanton, 31 October 1995; (b) *Time Magazine*, New York, 18 December 1995.
- <sup>13</sup> *ibid.*
- <sup>14</sup> Santilli, Ray, statement published on the Internet, June 1995.

- <sup>15</sup> MUFON Section, CompuServe Encounters Forum, Library, September 1995.
- <sup>16</sup> Kiviat and Roehring, *ibid.*
- <sup>17</sup> Stokes, Trey, "Special Effects: The Fine Art of Fooling People", *UFO Times*, BUFORA, Batley, England, January 1996.
- <sup>18</sup> Jansen, T., "Der 'Roswell-Alien': Progerie", *Munch. Med. Wschr.*, no. 9, Munich, Germany, 1996.
- <sup>19</sup> "Wie im Lehrbuch", in *Der Spiegel*, Hamburg, Germany, 23 April 1996.
- <sup>20</sup> Milroy, Christopher (Dr), statement, 2 June 1995.
- <sup>21</sup> Wachter, Hanspeter, "Der Roswell-Film", *Magazin 2000*, Neuss, Germany, no. 110, May 1996.
- <sup>22</sup> Kiviat and Roehring, *ibid.*
- <sup>23</sup> Roed, Odd-Gunnar, "Norwegian pathologist views the Roswell footage" (report), Oslo, Norway, March 1996.
- <sup>24</sup> *Misterii* (TV broadcast), RAI Due, Italy, 17 October 1995.
- <sup>25</sup>(a) *Modern Scientists and Engineers*, McGraw-Hill, New York, vol. 1, 1980;
- (b) *Current Biography*, New York, 1949.
- <sup>26</sup> Shell, Bob, personal communication, 25 January 1996.
- <sup>27</sup> *Who was Who*, p. 784 (copy without year given to Bob Shell).
- <sup>28</sup> Milroy, *ibid.*
- <sup>29</sup> Wachter, *ibid.*
- <sup>30</sup> Kiviat and Roehring, *ibid.*
- <sup>31</sup> *Misterii*, *ibid.*
- <sup>32</sup> Roswell footage TV broadcast, TF1, France, 23 October 1995.
- <sup>33</sup> Roed, *ibid.*
- <sup>34</sup> Santilli, "Operation Anvil", *ibid.*; personal communications.

- <sup>35</sup> Murphy, Dennis, "Discussion of Debris Details: Santilli Alien Dissection Film" (report), published on CompuServe Encounters Forum, 1 March 1996.
- <sup>36</sup> Malanga, Corrado (Dr), lecture, Roswell Symposium of the Republic of San Marino, 7 September 1995.
- <sup>37</sup> Allen, Bob (M.Sgt), personal communication, 24 January 1996.
- <sup>38</sup> Shell, Bob, personal communication, 18 February 1996.
- <sup>39</sup> Uhouse, Bill, statement on the Roswell footage panel, International UFO Conference, Mesquite, Nevada, USA, 1 December 1995.
- <sup>40</sup> (a) Zauzich, Karl-Theodor, *Hieroglyphs without Mystery*, University of Texas Press, Austin, Texas, USA, 1992.
- (b) Wallis Budge, E. A., *Egyptian Language*, Dover Publications, New York, reprinted 1983.
- (c) Wallis Budge, E. A., *An Egyptian Hieroglyphic Dictionary*, Dover Publications, New York, vols. 1-2, reprinted 1978.
- (d) Watterson, Barbara, *Introducing Egyptian Hieroglyphs*, Scottish Academic Press, Edinburgh, Scotland, 1993.
- (e) Robinson, Andrews, *Story of Writing*, London, 1960.
- (f) Naveh, Joseph, *Die Entstehung des Alphabets* ("The Origin of the Alphabet"), Palphol, Jerusalem, Israel, 1994.
- <sup>41</sup> Charroux, Robert, *Vergessene Welten*, Econ, Düsseldorf, Germany, 1974.
- <sup>42</sup> von Däniken, Erich, *Meine Welt in Bildern*, Econ, Düsseldorf, 1973.
- <sup>43</sup> Homet, Marcel (Dr), *Die Soehne der Sonne*, Walter, Olten, Switzerland, 1958.
- <sup>44</sup> Charroux, Robert, *Das Raetsel der Anden*, Econ, Düsseldorf, 1978.
- <sup>45</sup> Herrera, Salvador Lopez, *The Canary Islands through History*, Gráficas Tenerife, Santa Cruz (undated).
- <sup>46</sup> Wallis Budge, *An Egyptian Hieroglyphic Dictionary*, vol. 2, *ibid*.
- <sup>47</sup> Hesemann, Michael, *Cosmic Connections*, Gateway Books, Bath, UK, 1995.
- <sup>48</sup> Morning Sky, Robert, personal communication, December 1995.
- <sup>49</sup> Shell, Bob, personal communication, February 1996.
- <sup>50</sup> Brugger, Karl, *The Chronicle of Akakor*, Delacorte Press, New York, 1977.
- <sup>51</sup> (a) Friedman, S. and D. Berliner, *UFO Crash at Coronado*, Paragon, New York, 1992.
- (b) Randle, K. and D. Schmitt, *UFO Crash at Roswell*, Avon, New York, 1991.
- <sup>52</sup> (a) Document in the New Mexico Institute of Mining & Technology, Socorro, New Mexico, USA;
- (b) Wykel, L. and K. Kelly, "The Six Mile Canyon Crash Site" (report), Albuquerque, New Mexico, 24 September 1995.
- <sup>53</sup> Stringfield, Leonard, *UFO Crash Retrievals: Search for Proof in a Hall of Mirrors*, Cincinatti, Ohio, USA, 1994 (self-published).
- <sup>54</sup> Stringfield, Leonard, *UFO Crash Retrievals: Amassing the Evidence*, Cincinatti, Ohio, 1982 (self-published).
- <sup>55</sup> Wykel and Kelly, *ibid*.
- <sup>56</sup> Letter to Art Bell (radio talk-show host), 10 September 1995.
- <sup>57</sup> Personal interviews, 19 February 1996.
- <sup>58</sup> Marston, Howard, personal interview, 2 December 1995.
- <sup>59</sup> Shell, Bob, personal communication, 18 April 1996.
- <sup>60</sup> Allen, Bob (M.Sgt), personal communication, 24 January 1996.
- <sup>61</sup> Stone, Clifford (Sgt), as interviewed by Ted Loman, 20 February 1996.
- <sup>62</sup> Andrews, Colin, personal communication, 28 June 1995.

#### About the Author:

Michael Hesemann is a cultural anthropologist and historian who studied at Göttingen University. He is a best-selling author and award-winning film producer, with expertise in frontier sciences and extraterrestrial phenomena. He lives in Düsseldorf, Germany.

Since 1984, Hesemann has published and edited *Magazin 2000*, which comes out in German and Czech languages. His international best-sellers, *UFOs: The Evidence*, *A Cosmic Connection* and *UFOs: A Secret Matter* have been published in 14 countries, with a distribution of more than 500,000 copies. His latest book, *Beyond Roswell* (with Philip Mantle), on his investigation into the controversial alien autopsy footage, will be published towards the end of 1996 by Marlowe, New York.

Michael Hesemann has produced several award-winning documentaries, such as *UFOs: The Secret Evidence* and *UFOs: Secrets of the Black World*, and has worked for TV programmes in Germany, Japan and the US.

He has spoken at international conferences in 22 countries across five continents, at 30 universities, and at the United Nations. He is an associate member of the Society for Scientific Exploration.

Continued from page 72

ror. Your physicality is composed of atoms which form into molecules, which then become cells. You are a symphony of electrons, atoms and molecules of intent. All of you are a complex of intents or desires. Many of you walk around and ask for a miracle, when you are in fact *that* which you ask for. From beginning to end, physical matter is a network of intent. The Is-ness spins consciousness into the matter, and then what you have is *life*. What you see and experience is only the smallest part of you, the outer expression of an inner event. The pattern for your human form is created in Spirit, and the body is composed of a collection of intents, each one having a particular function, all geared toward the sustenance of your humanness."

### Questions and Answers

**Q:** Is there some technique you can recommend for self-improvement?

**AC:** Yes. I was given a meditation or exercise. It's a long story on how I got it out of Morenae, but I was having trouble seeing my inner light. Basically, you get yourself comfortable and go down within

yourself physically and turn yourself inside out from the balls of your feet to the top of your head. Everything on the inside will be then on the outside. Everything on the outside is now on the inside. When you start to see your body upside down, you are on the right track. That has helped me the most. The other thing is quiet time. Make some quiet time for yourself.

**Q:** If we are going to be going from third density, through fourth density and into fifth, what does it matter if the government is trying to manipulate everything? How is that going to affect us?

**AC:** The whole point of the manipulation is to try to hold us back.

**Q:** To prevent us from going into that dimension?

**AC:** To prevent as many as possible. Now, when we talked about the creation of our Universe and the metaphor of the weight of the regressives, all of those who are not going to be moving into fifth density are going to create another space of consciousness, a universe, and continue to play this game until they get it right.

**Q:** You said that the Andromedan Council has ordered that all ETs are to be off the planet by 12th August 2003. How

will this affect the alleged aliens coming in terms of Comet Hale-Bopp? Won't these aliens have to leave by that time? How will they get rid of them?

**AC:** Right. They have not told me how they plan on getting rid of them. I don't know if they know. All they have said is that they will remove all ETs from our planet—by force if necessary.

**Q:** What do they say about the human propensity to use drugs as a method for invoking altered states of consciousness?

**AC:** I have asked them about that and they say that it causes a focus on the physical as a method for acquiring spirituality. It is a focus in the wrong direction. Their perspective is that we are already awakened, but 'stuck' on the physical.

**Q:** From what I can gather, the Andromedans are asking us to question our belief systems about reality and matter.

**AC:** That's right. We have gotten so stuck in dictating our truth based on experience, instead of creation of our experiences. When we get stuck in the idea of just experiencing things, we get stuck on the idea, "I feel alive because I'm having these experiences". Many people are stuck on survival, and you can get addicted to

survival because you 'feel alive'. You always 'take it to the edge' and you get stuck there. What happens is that you start going around like a hamster on a wheel. All you do is experience survival, and we get stuck in that concept. All you create is survival, survival, survival, survival—round and round and round the circle you go, instead of creating something else.

**Q:** What we perceive is that we live in a reality of cause and effect, when in fact the truth is that this is a reality of effect and that the cause is outside of this?

**AC:** Yes.

**Q:** So the bottom line is that there is no life or intelligence in matter?

**AC:** Yes. It reflects back to you the value you put on it.

**Q:** So the idea of altering matter to change our situation is one of the greatest lies perpetrated on humanity, as well as the tendency to look outside of ourselves for the truth?

**AC:** Yes.

**Q:** You mentioned before that some of us have, in a sense, come back from the future to "right a terrible wrong". If that is so, then the regressives could also travel back to change things. Couldn't this set up

a 'time loop' that could go on repeating itself?

**AC:** Yes, but there is one other factor. That is what occurred on 23rd March 1994 when the colour-sound frequency began emanating from the black holes, and that changed all the games and has brought everything to a focal point.

**Q:** How often are you contacted, and do you try to initiate contact?

**AC:** I try to initiate it, I really do. Probably once to twice a month. The majority of contacts have been telepathic in the last eight months. The Grey clones and the Pleiadians are in full civil war right now in the Sirius B system. The quarantine around our solar system has been broken and there are skirmishes going on all over the place. Things are heating up. The regressives are reacting big-time because their fear is becoming compressed as their density is compressing. All of their emotions are mirroring back to them.

We are doing that on Earth as well. Many people are starting to get 'buggy'. It's the energy which is compressing on itself. If you are restrictive inside yourself with the energy, it's going to react and come out of you and you are going to lash out. The

Earth is going to be doing this. When we have the *real* earthquakes, where the whole Earth will shudder—and it's going to happen—this is the Earth releasing the negativity that it has been holding onto. The Earth cannot take that low frequency with it into fifth density, so it is going to release it. And it's our own stuff. The Earth will be mirroring back our own stuff.

We are a race of beings living on a planet. We are a race, regardless of the colour of our skin. This is the only planet in our galaxy where all these races live together. This is it, and they've got us warring with each other. We are being duped. Don't turn on each other. We are all we have. When the Andromedans come down here, they don't look at people with different skin colours as different races. They look at us as one race. They are right to do so. ∞

The bimonthly newsletter, *Letters from Andromeda*, is available from  
Jon and Deborah Robinson,  
289 S. Robertson Blvd, #212,  
Beverly Hills, CA 90211, USA.  
Subscription cost in USA is  
USD\$19.98.